

SO70024

1/700 IJN Kinugasa 1942 / Aoba 1945
Premium Detail Set for Hasegawa kits

**Shelf
Oddity**

衣笠

青葉

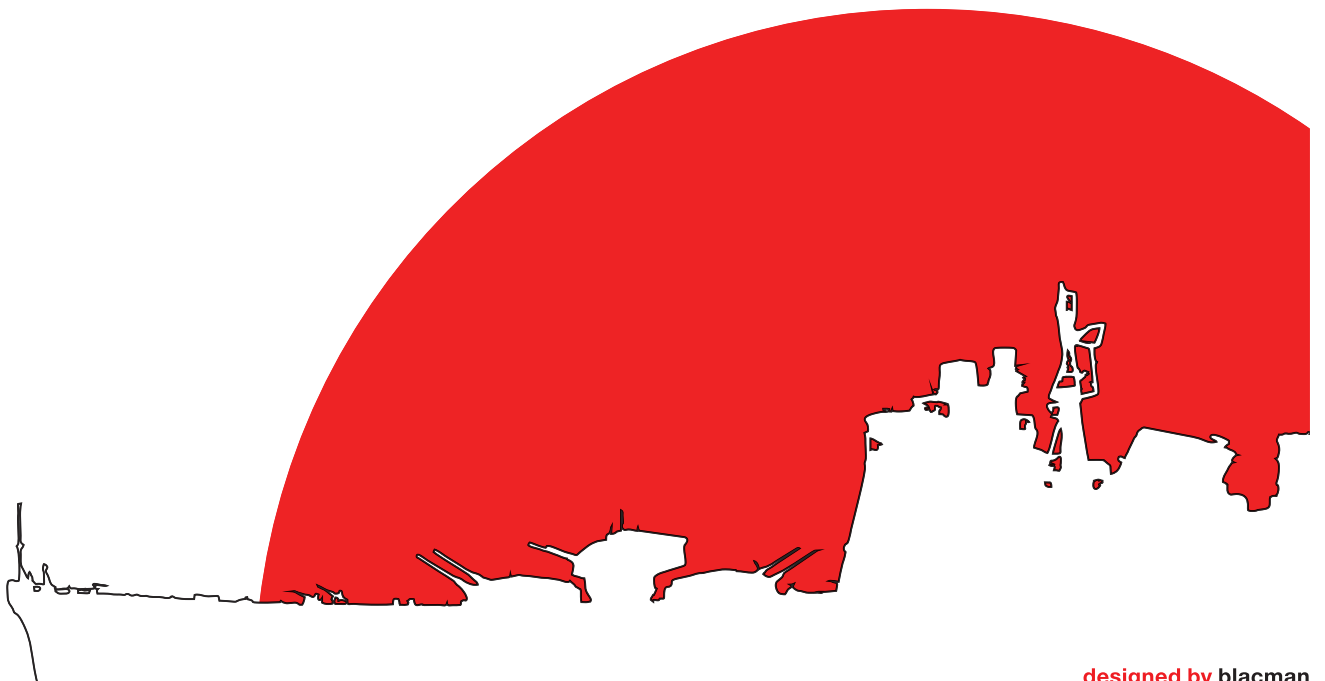

designed by blacman

SO70024

1/700 IJN Kinugasa 1942 / Aoba 1945

Premium Detail Set for Hasegawa kits (cat nos. 43169 and 43166)

Material remarks:

This set has been designed with 0.02 mm accuracy on extremely thin brass.

Etching process may decrease some dimensions and create irregularities.

The “edge-to-edge” assembly method using glue is highly recommended.

Be careful while bending photoetched parts – please follow the information shown below.

A general rule of bending photoetched parts.



Unless indicated otherwise, parts should be bent in a way to close the engraved notch inside of the bend.

Set also contains tailored 3D-printed parts. The resin used for these parts is fragile.

Using extensive force or aggressive attempts of removing material may lead to accidental breakage.

Please pay high attention when selecting the tooling for work with resin. Do not over-apply force while cutting and drilling in resin.

Photoetched fret A

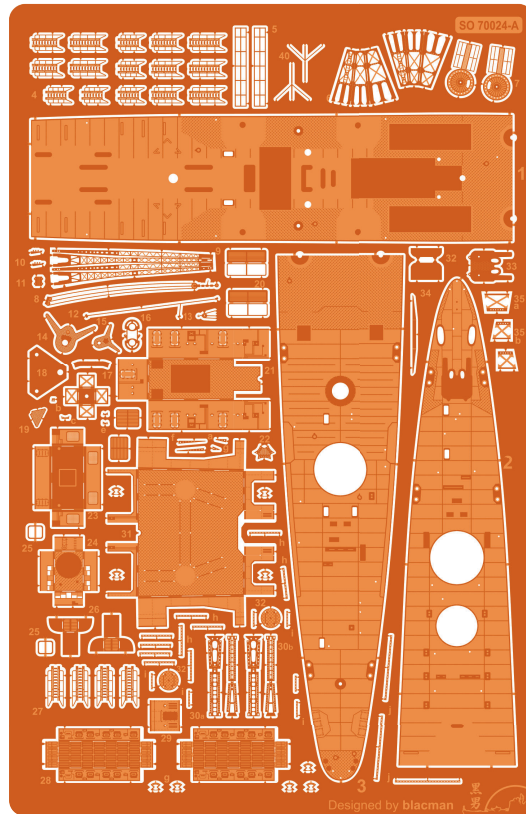

Photoetched fret B

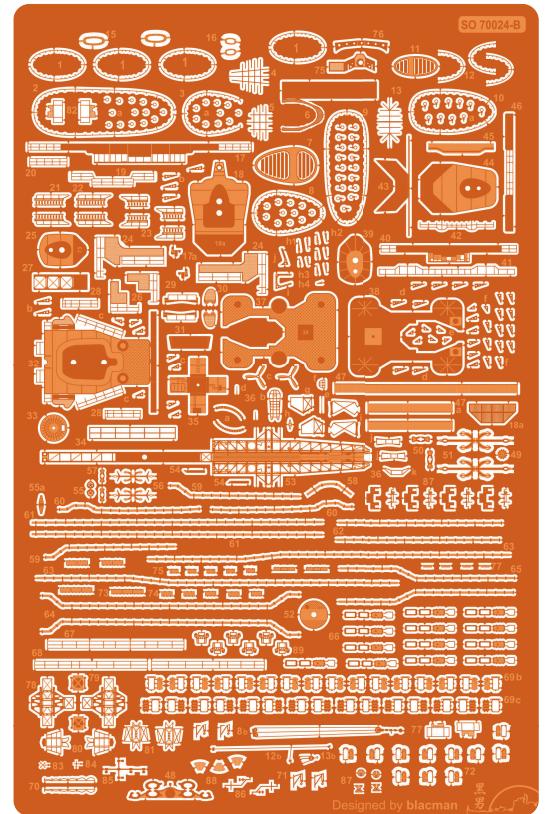

Photoetched fret C

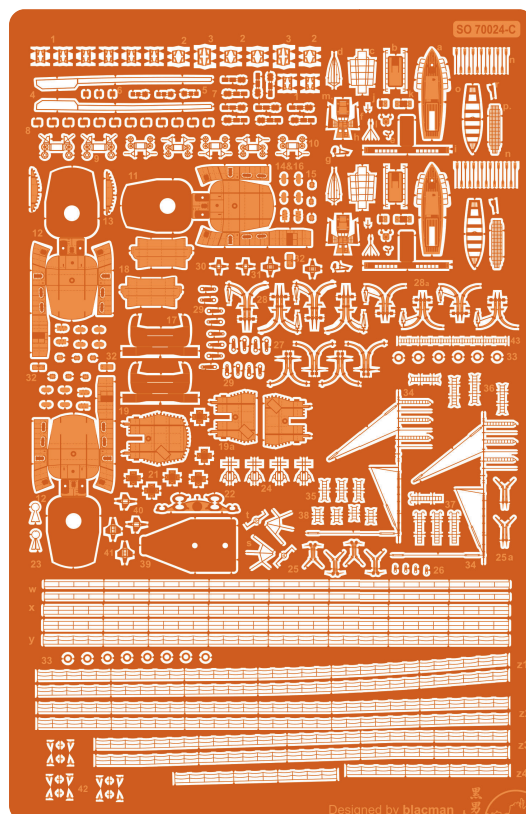

Photoetched fret D

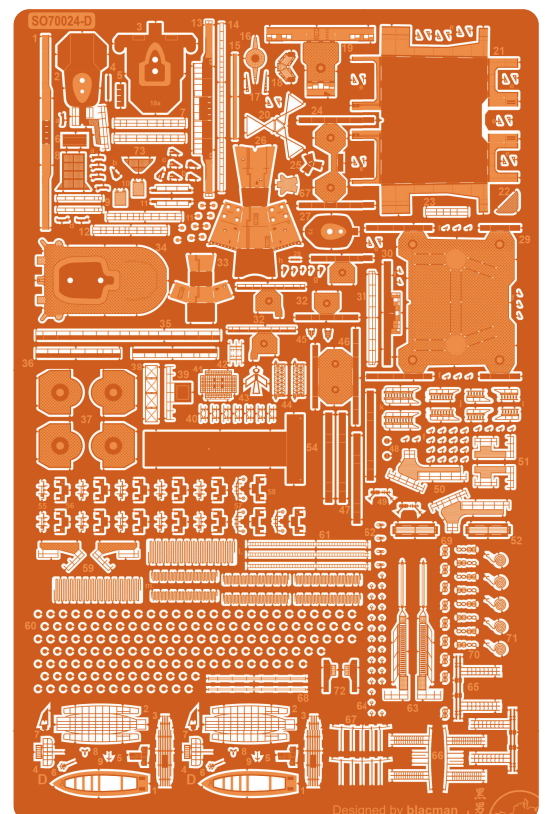

Set information:

The parts of this set are intended to be a direct replacement or to complement standard injection parts.

While reading this manual you might see some generic photoetched, brass tubes or plastic parts which are not included in this set.

Please note that some parts existing on photoetched frets are not indicated in this manual. Their location is either typical for IJN vessels or may vary depending on the period you chose to depict the ship from.

Colour code:

-  Original parts from Hasegawa kit
-  Shelf Oddity resin parts
-  Shelf Oddity photoetched parts

 Shelf Oddity CNC tooled brass parts

Recommended other scratch materials:

Plastic (brass) rods of 0.15, 0.2, 0.25, 0.3 and 0.4 mm diameter.

0.06 mm rigging wire (can be purchased separately in our webstore as **SO70050** reel)

Resin plates E

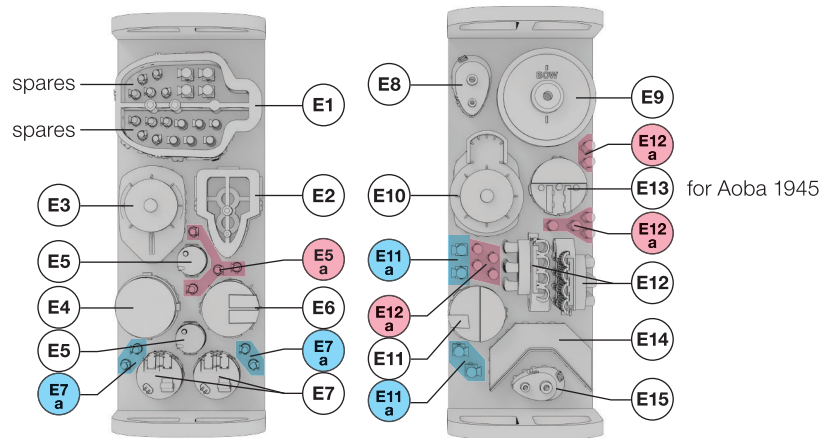

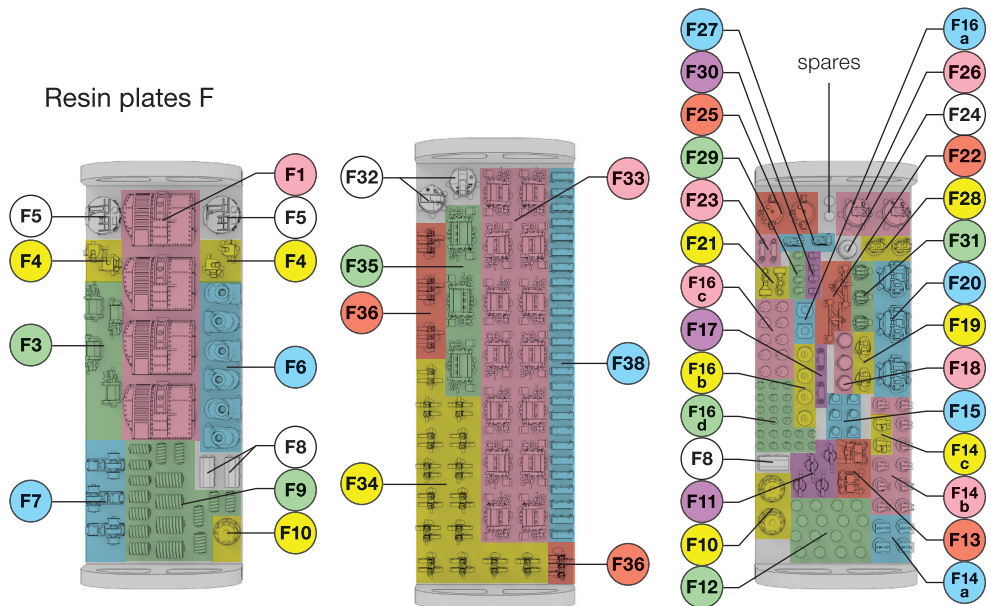

Resin plates F

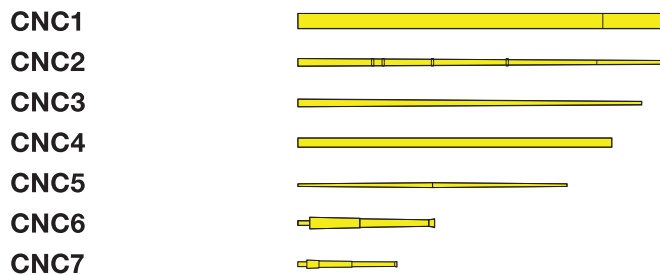

CNC Brass tooled parts



A pattern for scratchbuilding Aoba foremast (parts not included in the set)

2x Ø 0.3 x 31 mm rod		1/1 scale
Ø 0.3 x 20 mm rod		1/1 scale

SO70024

1/700 IJN Kinugasa 1942 / Aoba 1945

Premium Detail Set for Hasegawa kits (cat nos. 43169 and 43166)

IJN Kinugasa 1942 section plan and deck fittings:

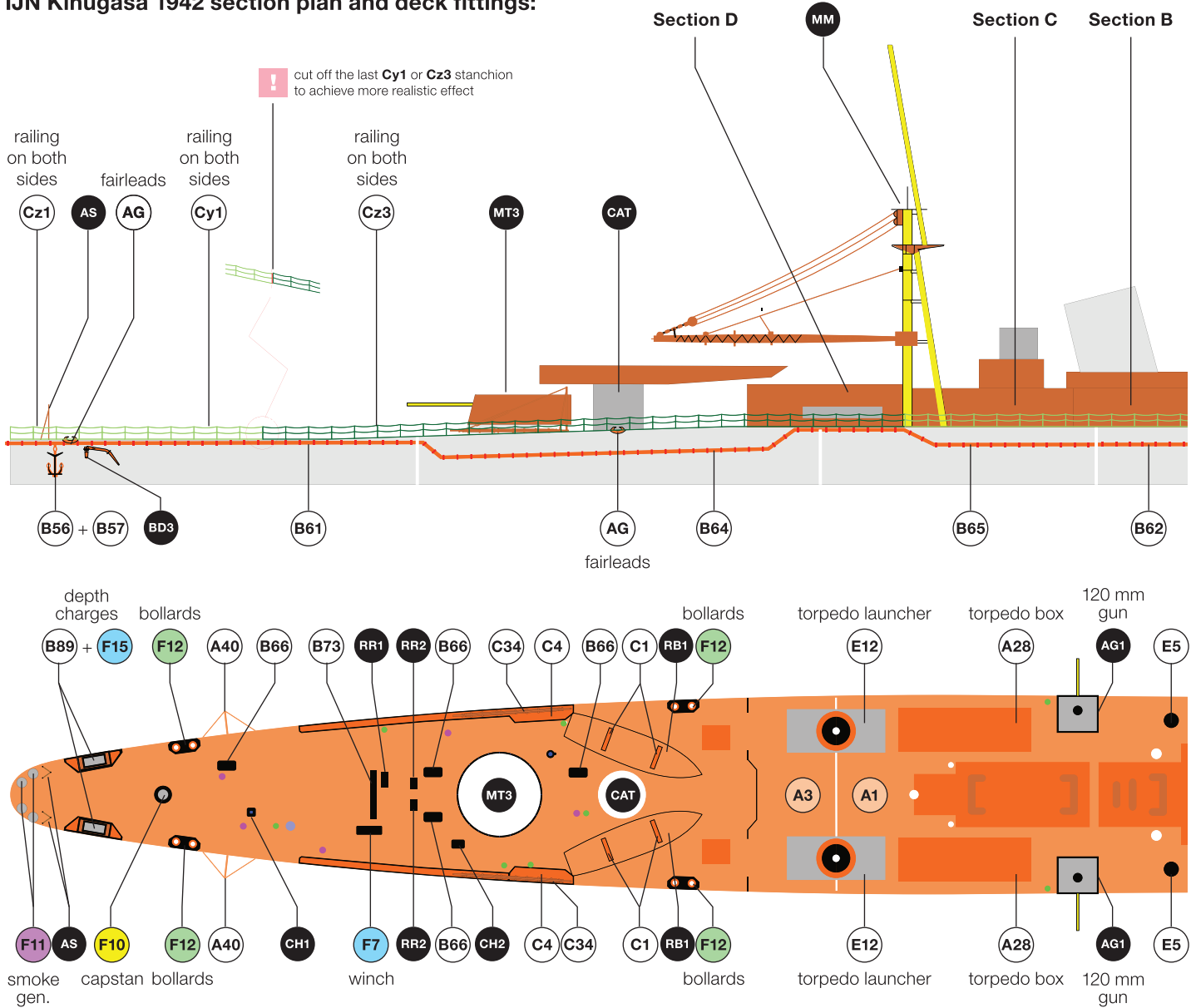

CH Crew hatches:

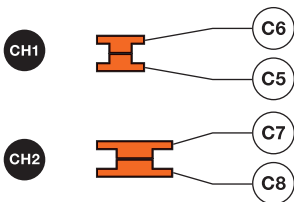

AS Antenna stanchions:

! need to be scratchbuilt from 4 mm long pieces of 0.1 mm Ø brass rod



Deck ventilators:

- F16a (weatherproof)
- F16b (big)
- F16c (medium)
- F16d (small)

Boarding booms and ladders:

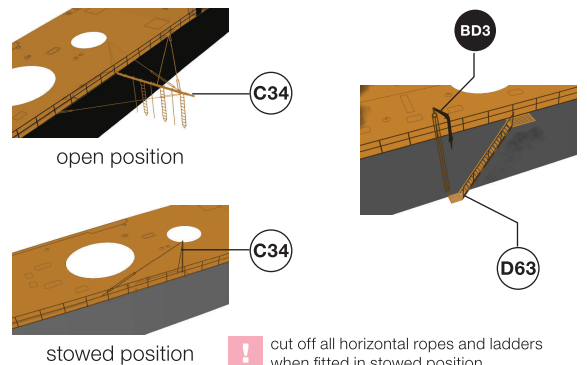

! Rope splinter shields (**Dm** – two kinds) and rope whorls (**D69**, **D70** and **D71**) can be placed in various locations of the ship. Check your references when selecting their placement.

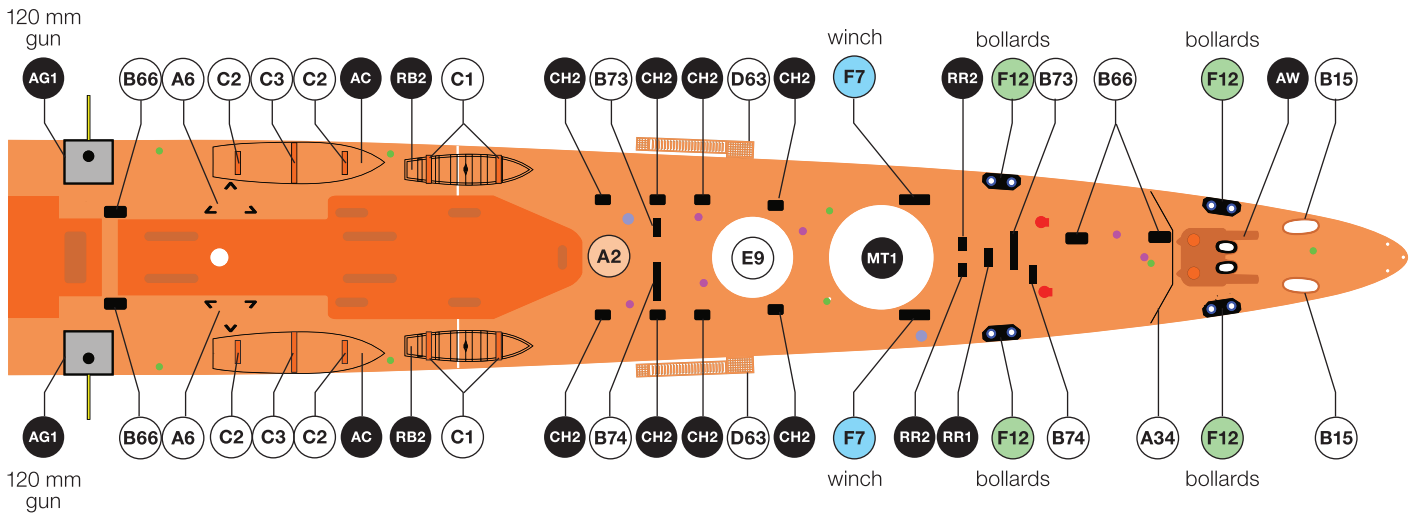
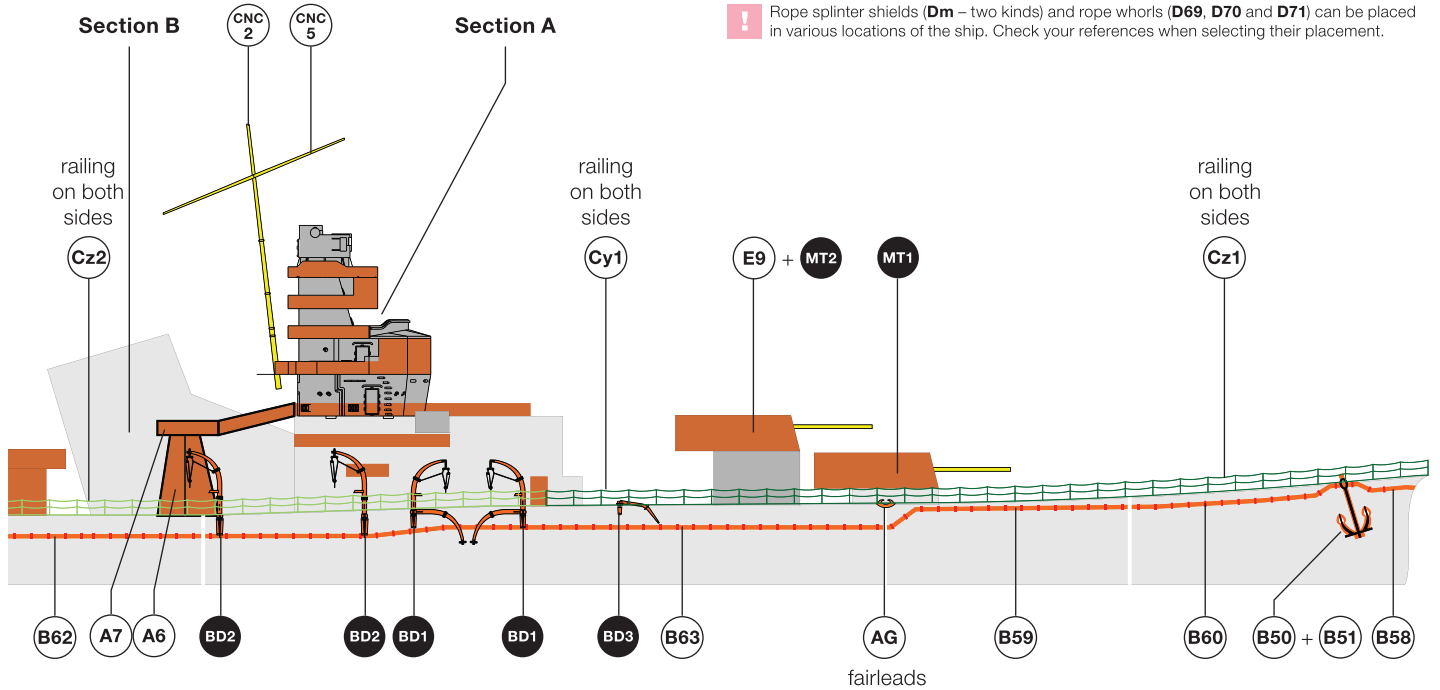

BD Boat davits:

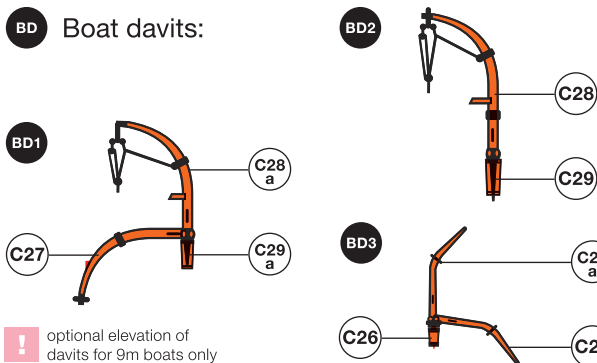

! optional elevation of davits for 9m boats only

RR Rope reels:

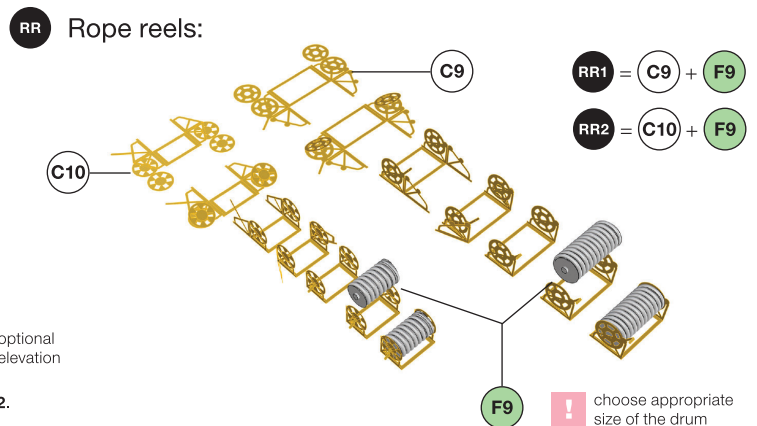

! optional elevation

$$RR1 = C9 + F9$$

$$RR2 = C10 + F9$$

! choose appropriate size of the drum

! Boat rope ladders (**D65**, **D66** and **D67**) can be placed between boat davits **BD1** and **BD2**. Check your references when selecting the ladder layout.

SO70024

1/700 IJN Kinugasa 1942 / Aoba 1945

Premium Detail Set for Hasegawa kits (cat nos. 43169 and 43166)

Deck fittings:

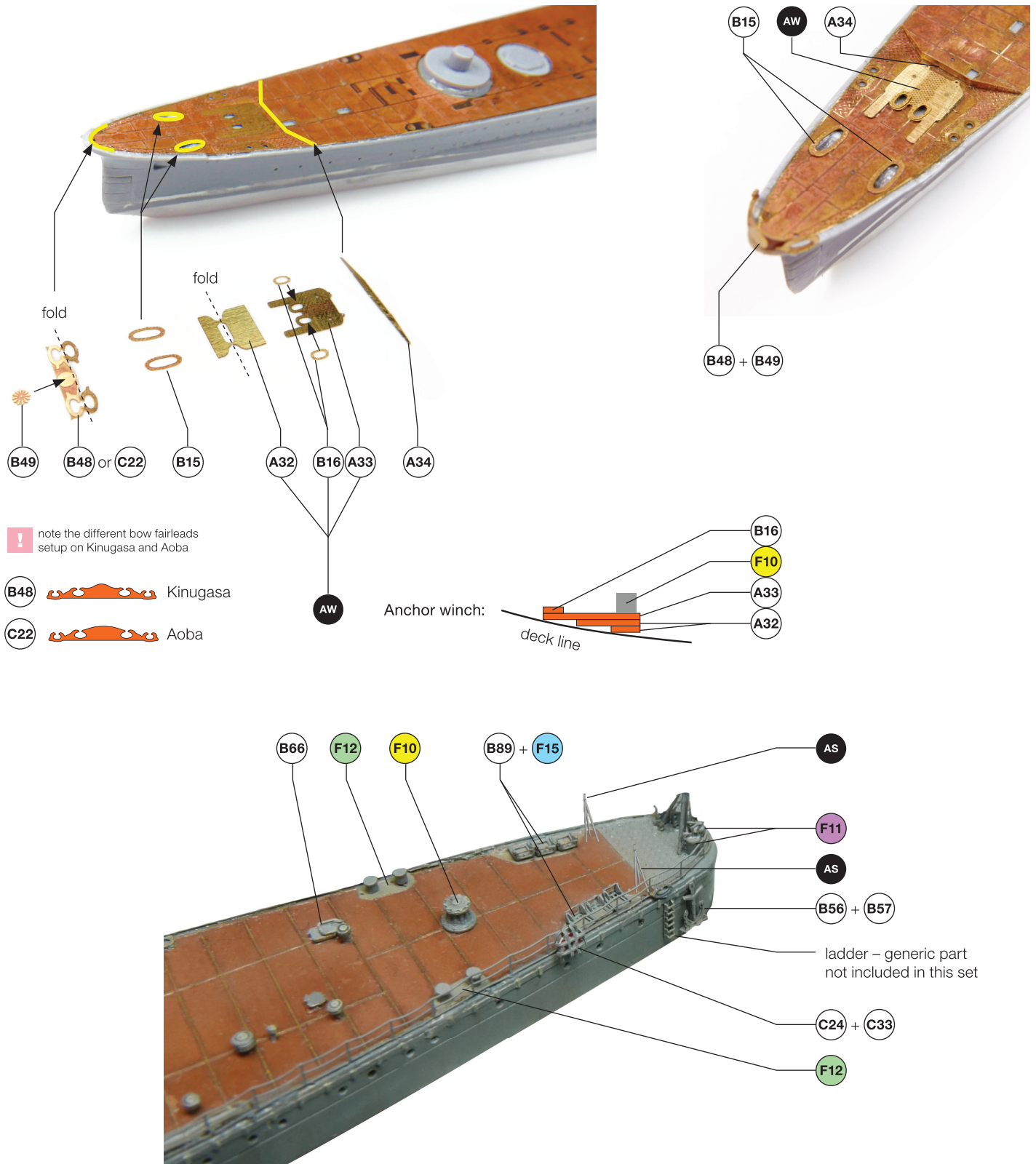

Section A – bridge area:

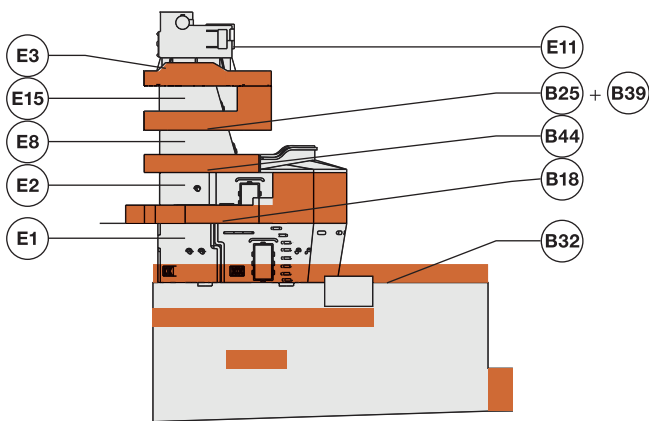

IJN Kinugasa 1942

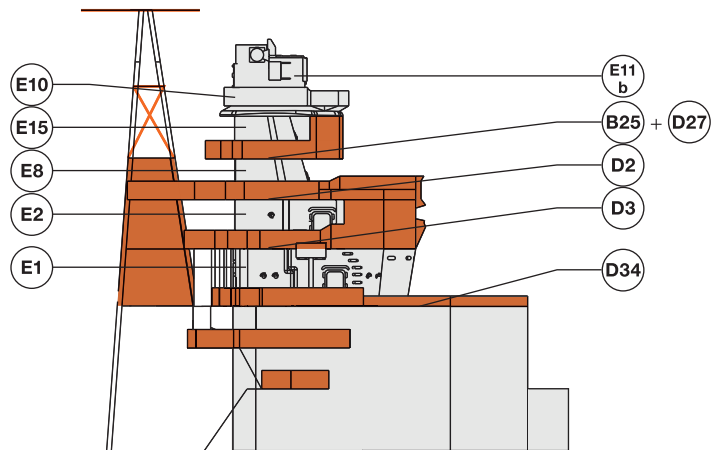

IJN Aoba 1945

! 13.2 mm MGs can be purchased separately as **S0700140** set.

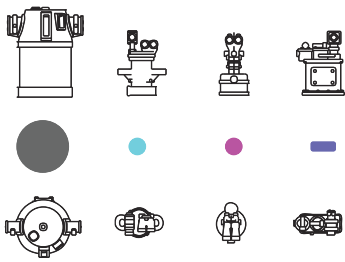

Optical equipment

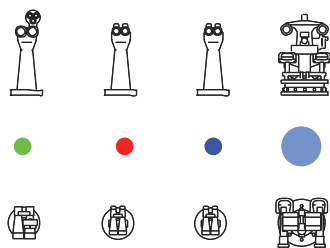

Additional equipment of a compass bridge

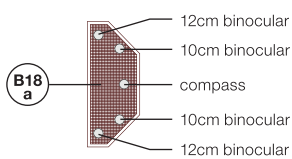

! These items are not included in this set
! The layout is identical for Aoba and Kinugasa

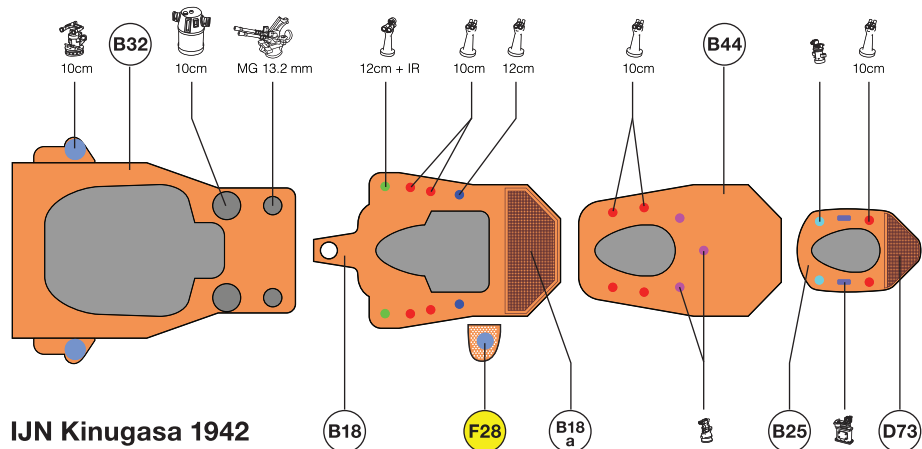

IJN Kinugasa 1942

on both sides

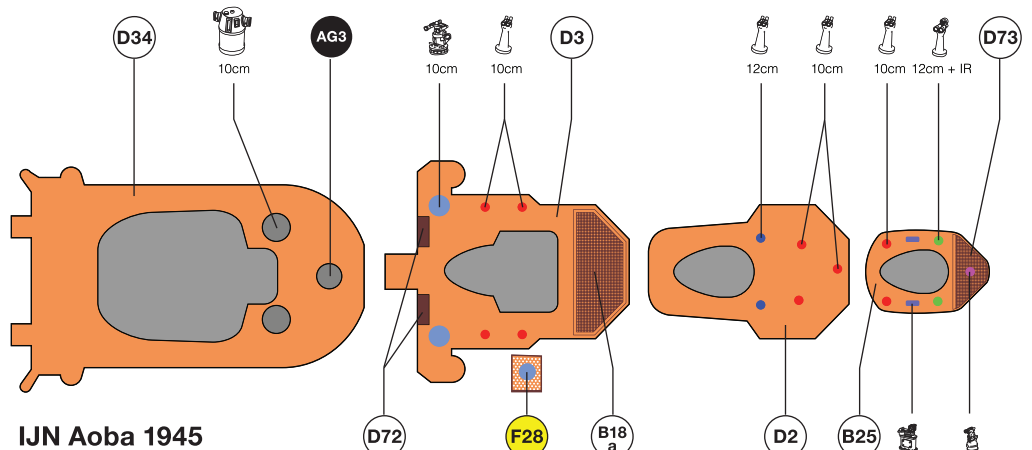

IJN Aoba 1945

Aoba only on both sides

SO70024

1/700 IJN Kinugasa 1942 / Aoba 1945

Premium Detail Set for Hasegawa kits (cat nos. 43169 and 43166)

Section A – bridge area:

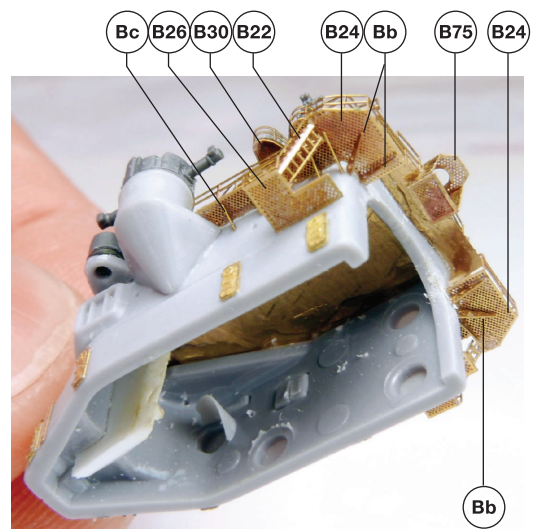
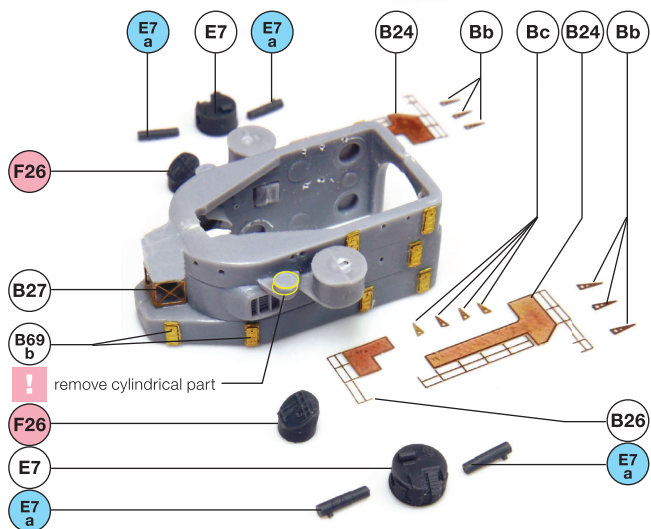
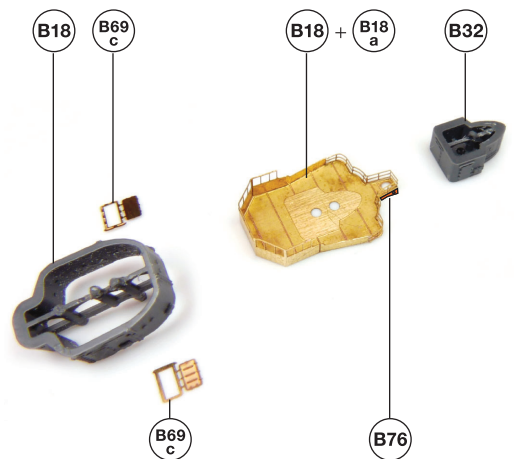
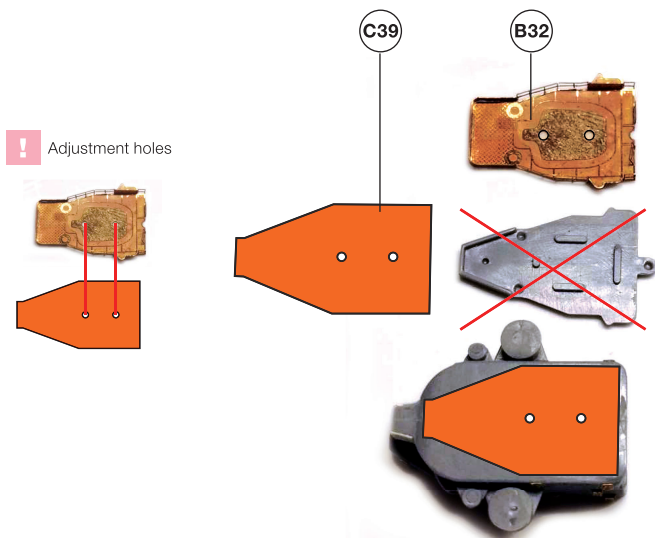
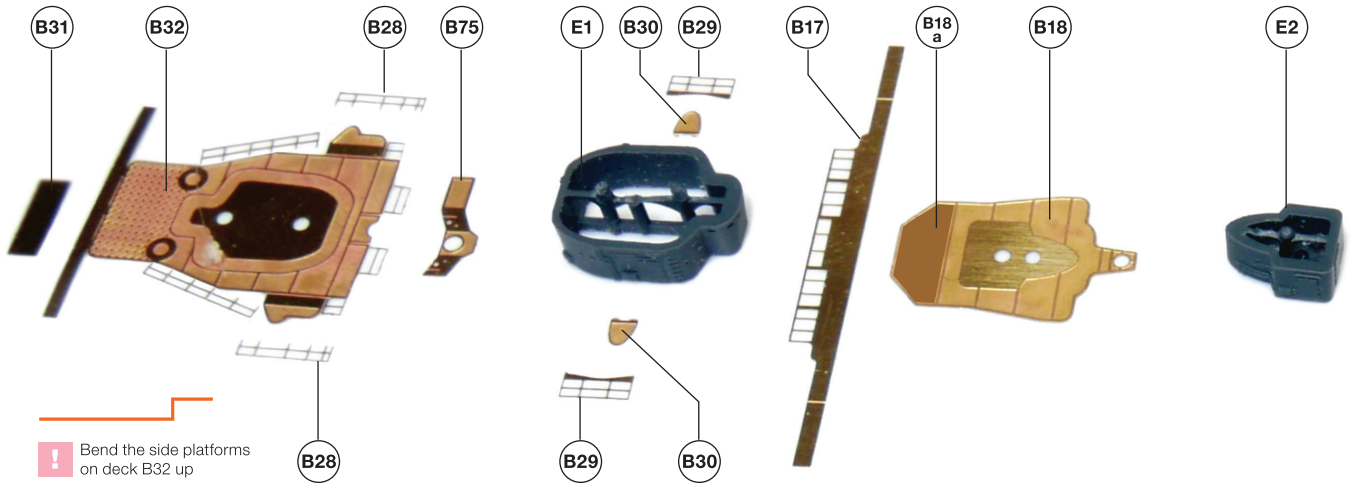

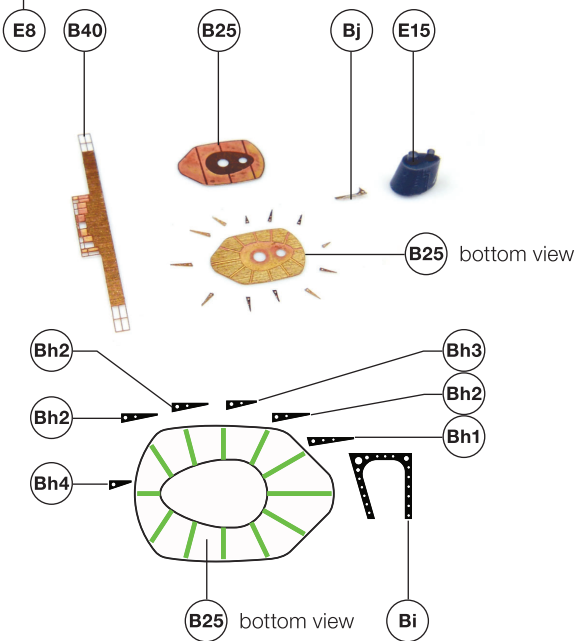
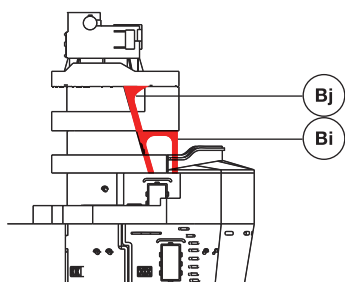
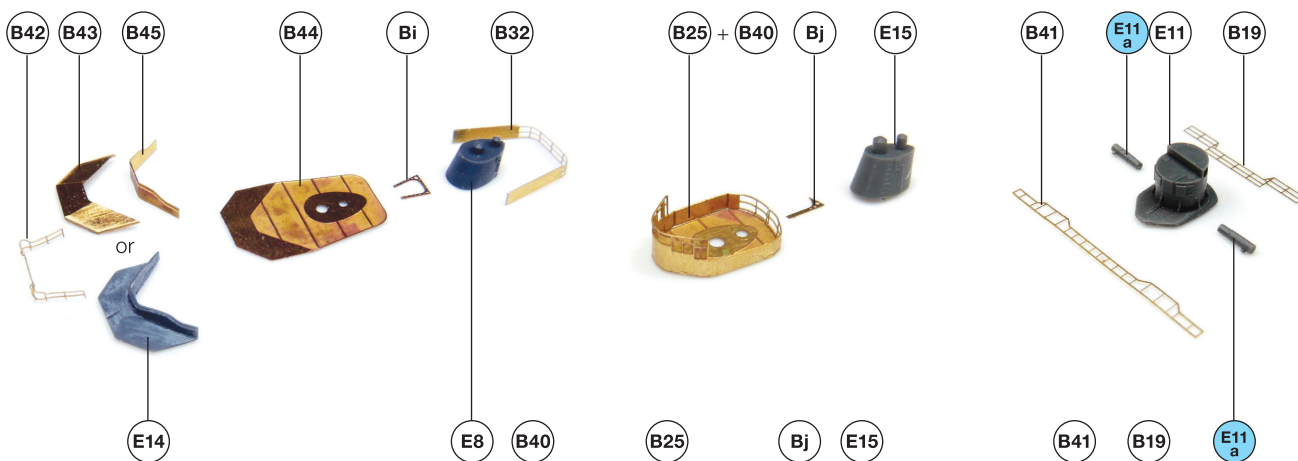
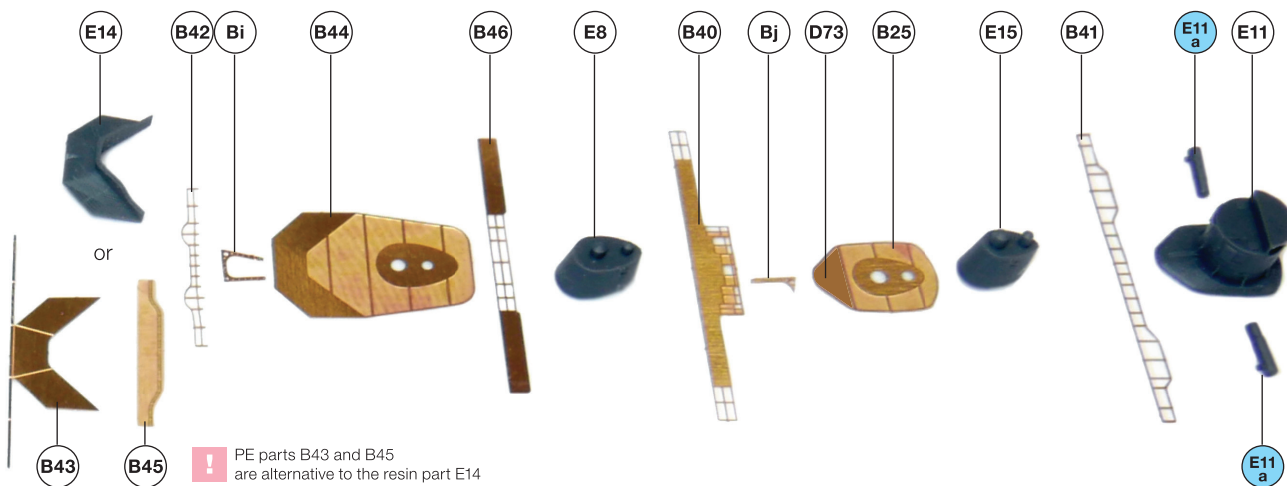

SO70024

1/700 IJN Kinugasa 1942 / Aoba 1945

Premium Detail Set for Hasegawa kits (cat nos. 43169 and 43166)

Section A – bridge area:

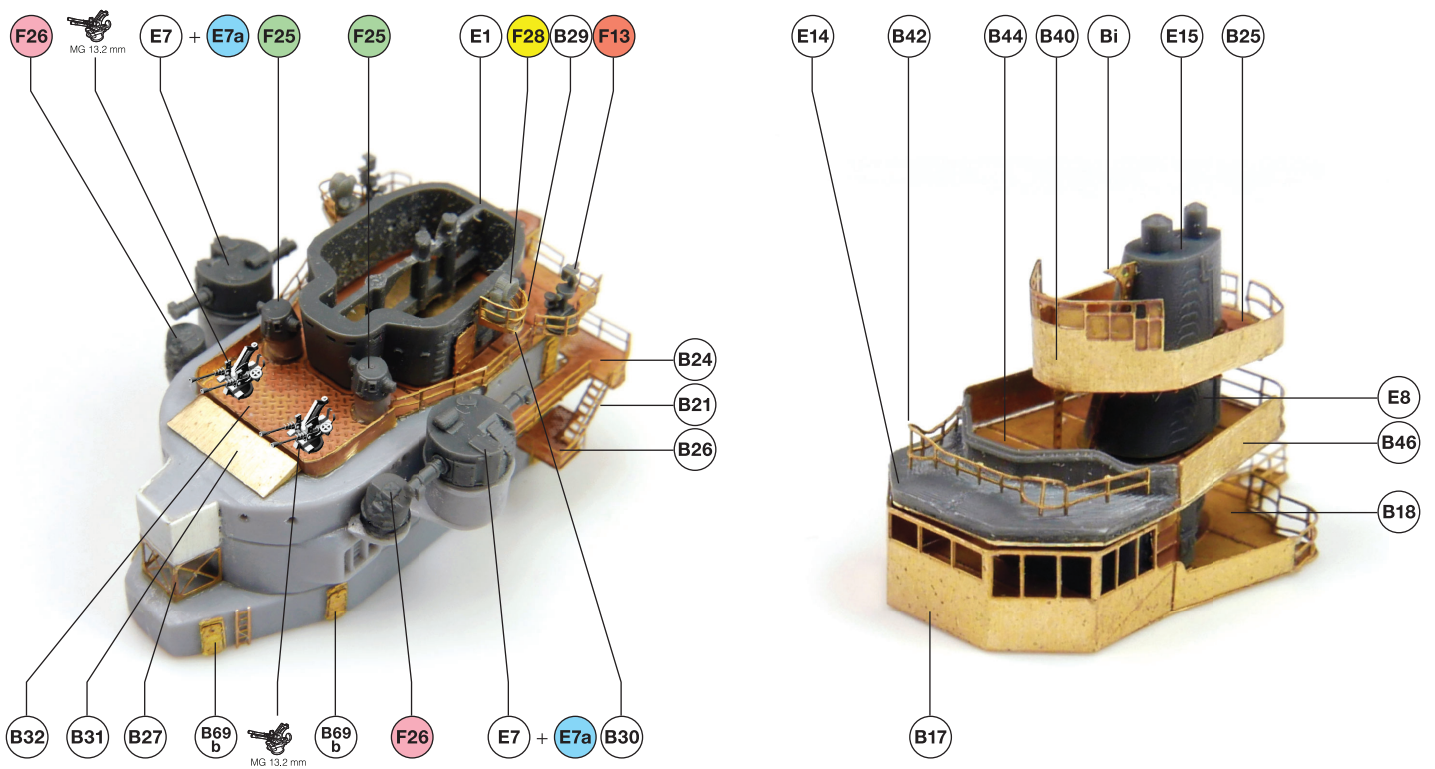

! 13.2 mm MGs can be purchased separately as SO700140 set.



Section B – funnels:

! Funnel drawings shown below are reproduced in 1/700 scale.
Use them as a pattern to prepare pipes from Ø 0.3 mm brass tubing.

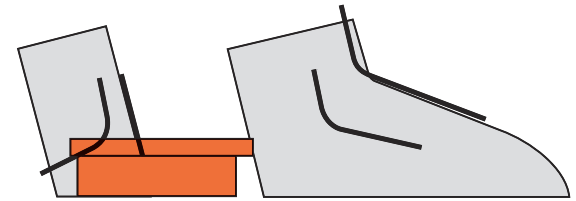
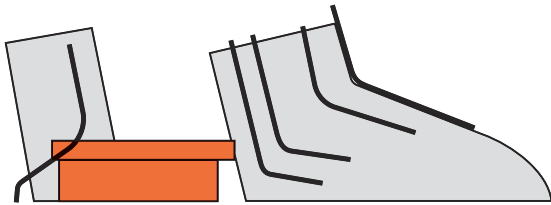

IJN Kinugasa funnels piping scheme

IJN Aoba funnels piping scheme



! Remove the plastic imitation of ribbing and pipes in order to utilise respective brass parts from this set.

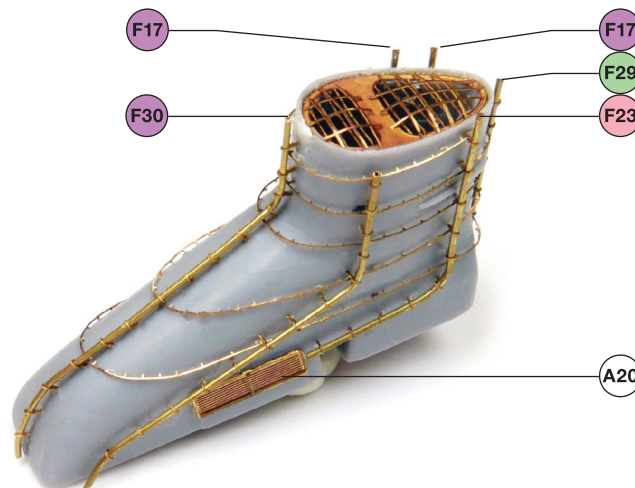
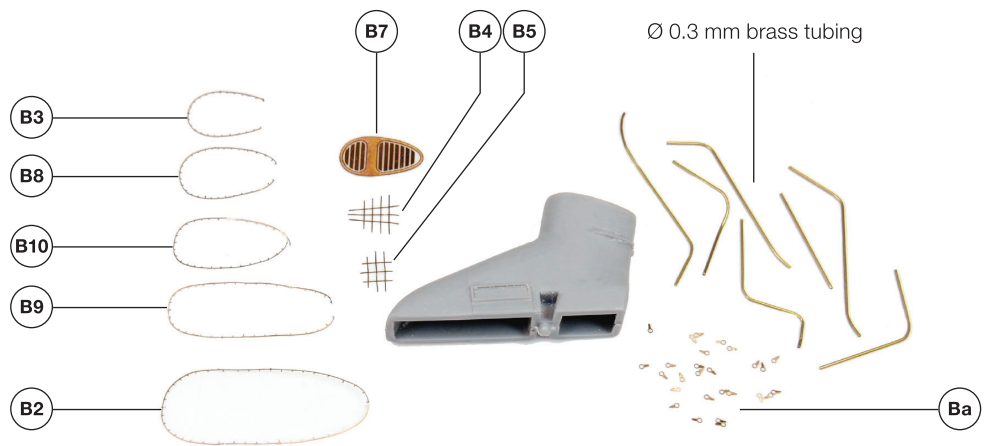

SO70024

1/700 IJN Kinugasa 1942 / Aoba 1945

Premium Detail Set for Hasegawa kits (cat nos. 43169 and 43166)

Section B – funnels:



! Remove the plastic imitation of ribbing and pipes in order to utilise respective brass parts from this set.

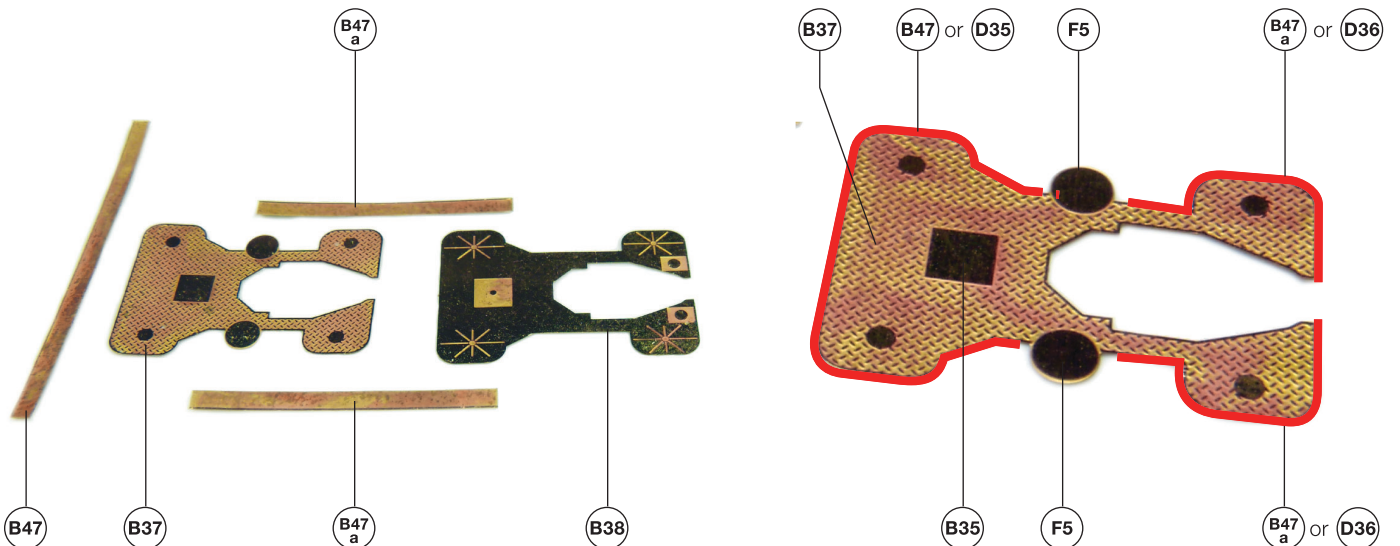
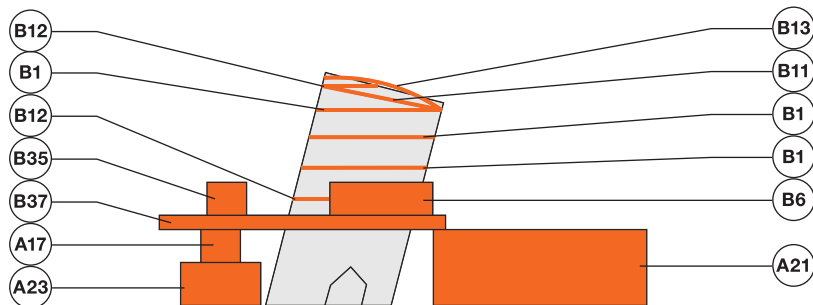
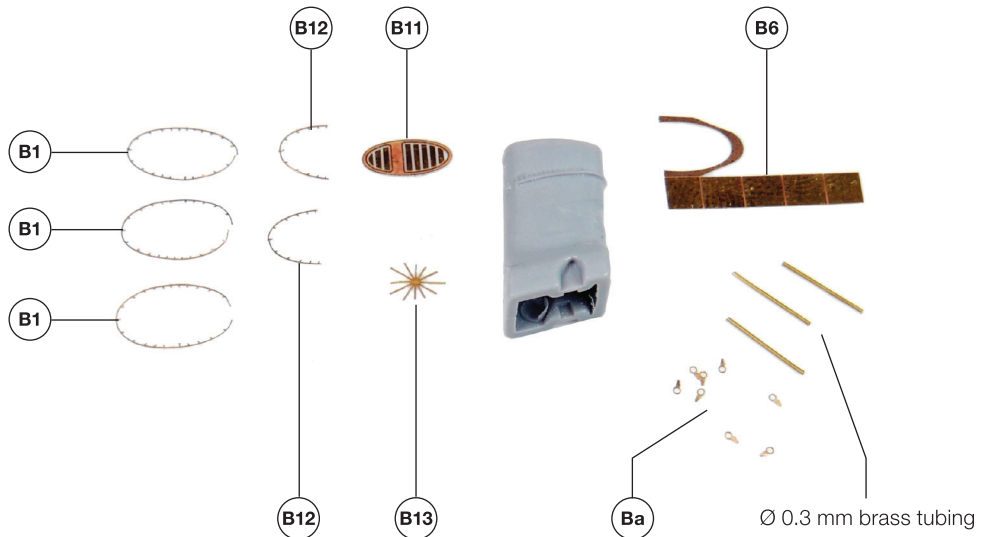

Section B – midship superstructure:

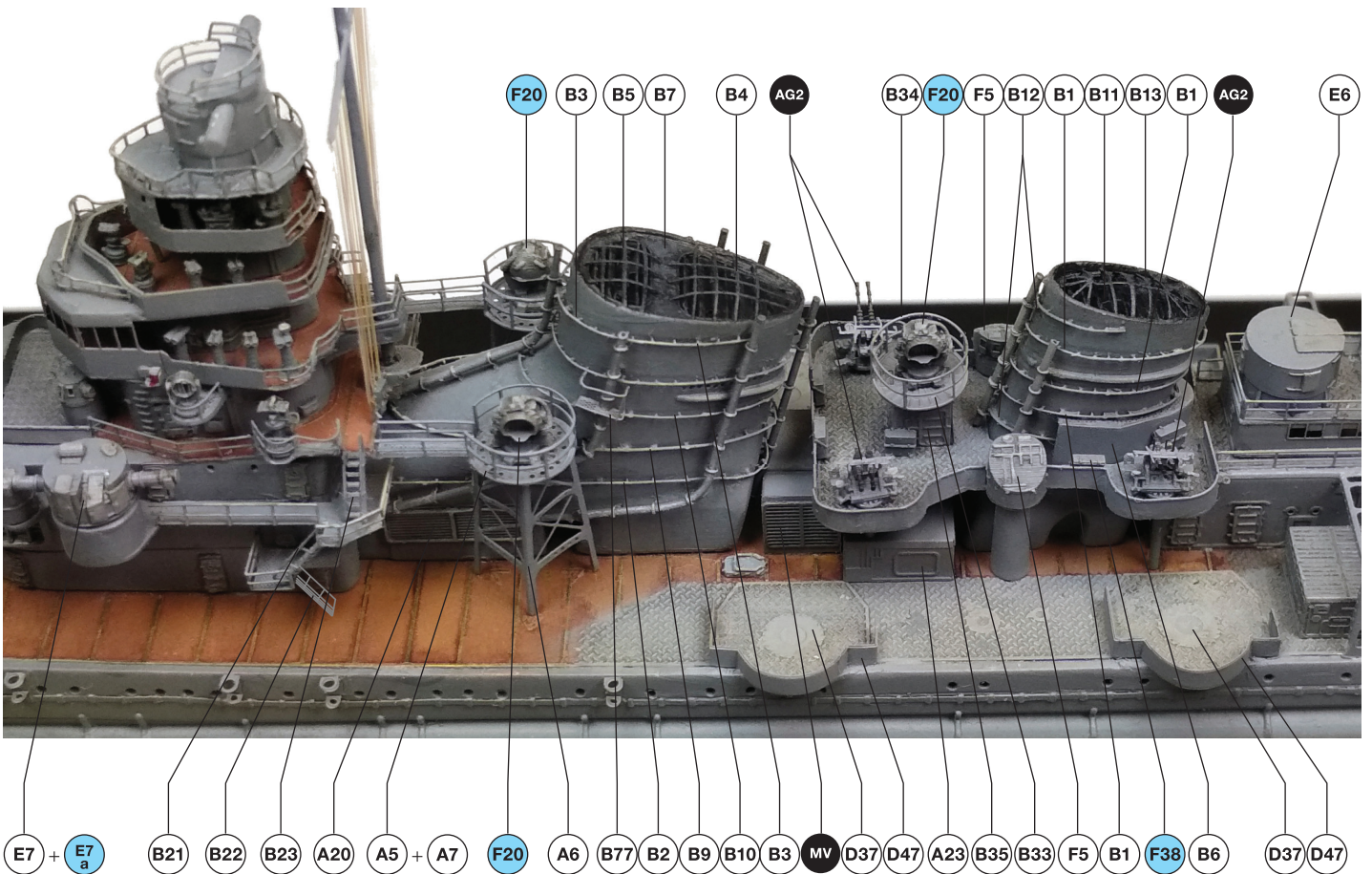
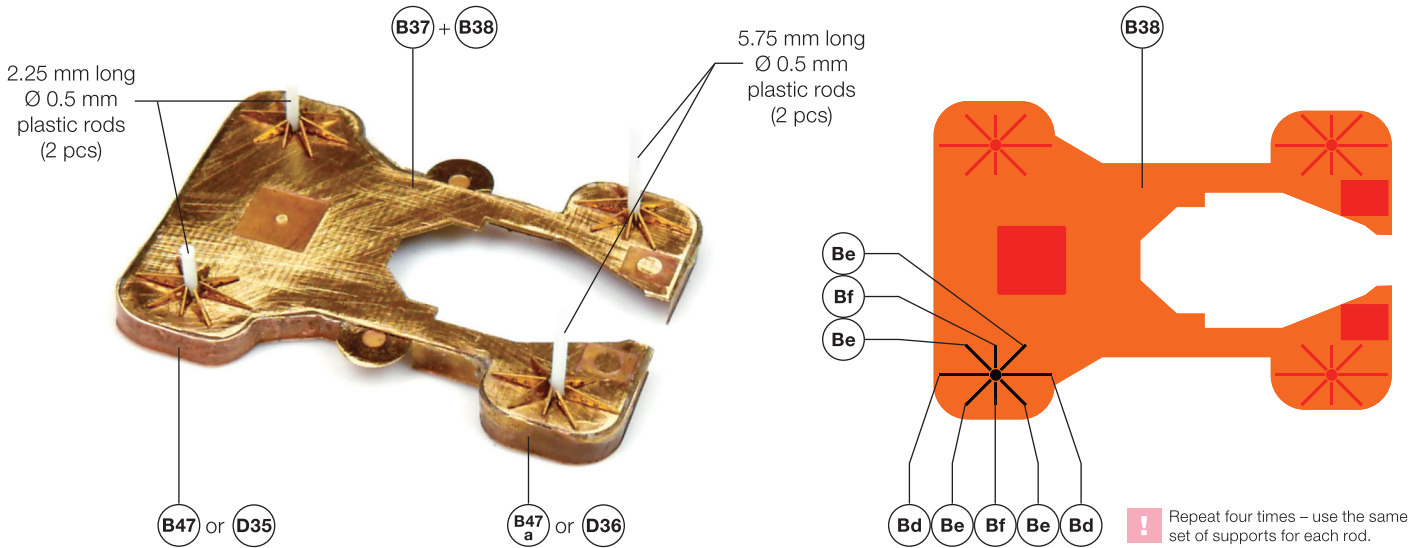

SO70024

1/700 IJN Kinugasa 1942 / Aoba 1945

Premium Detail Set for Hasegawa kits (cat nos. 43169 and 43166)

Section C – rear superstructure

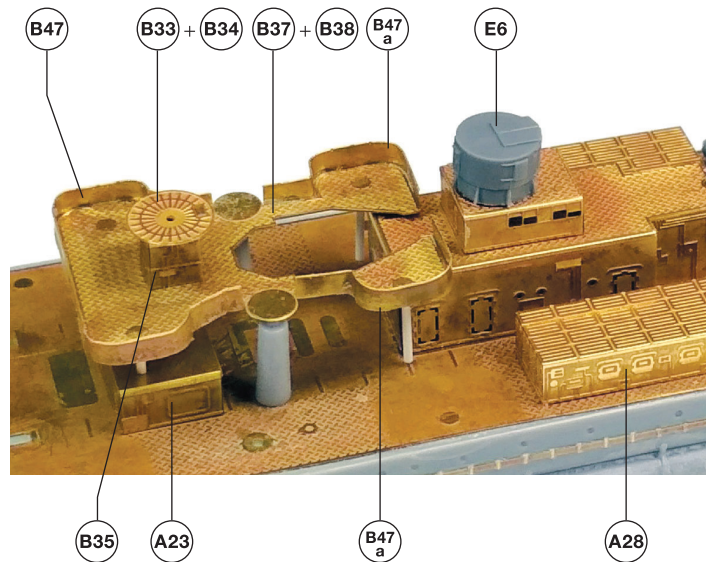
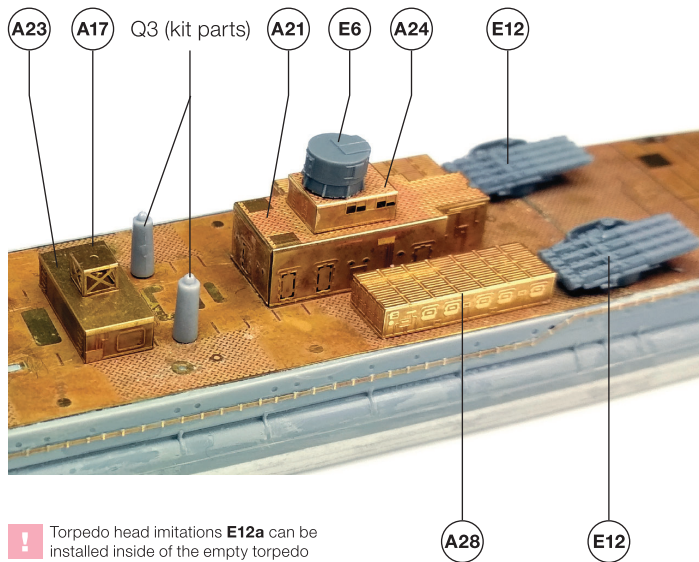

! Torpedo head imitations **E12a** can be installed inside of the empty torpedo tubes (**E12**).

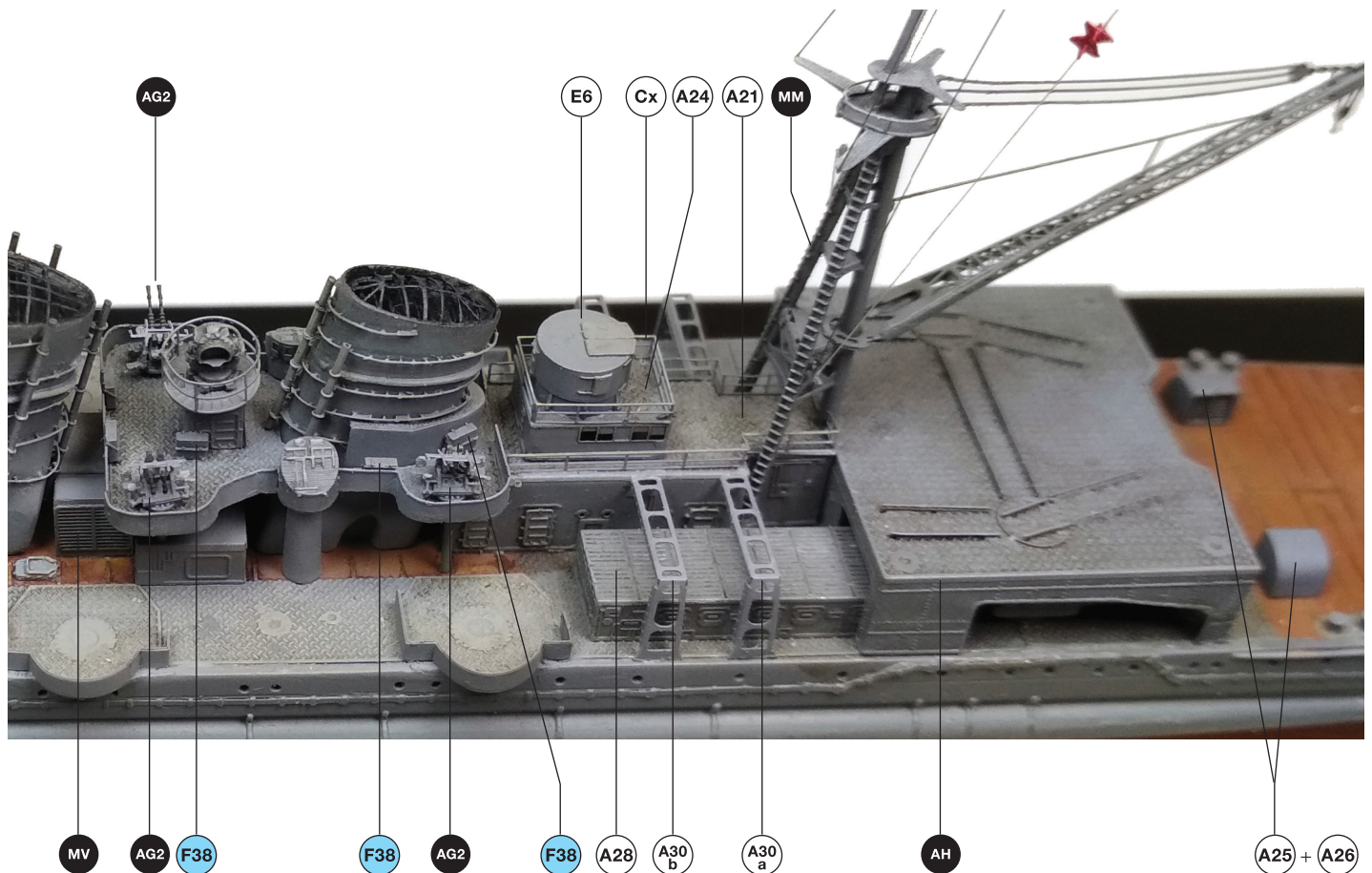



Section D – hangar and catapults

AH Aircraft hangar

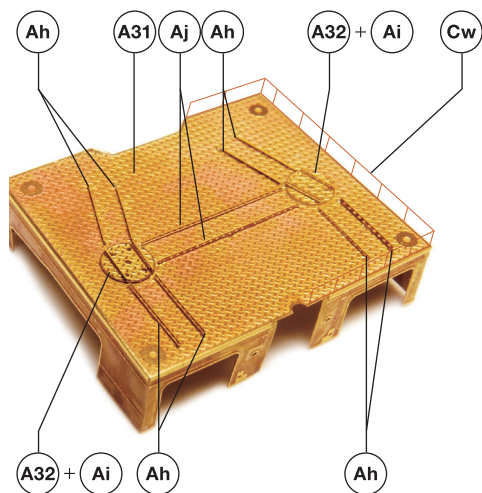

! Railing **Cw** is optional – it was used when there were no hydroplane operations.

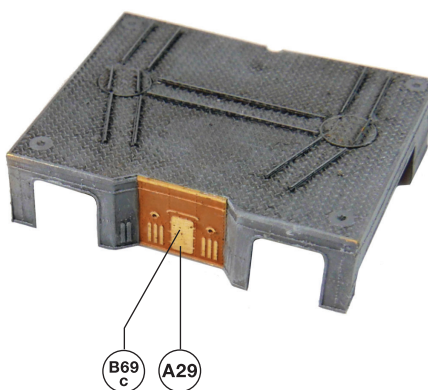

AT Aircraft trolleys

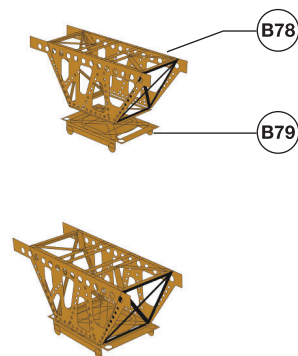

! Parts **D38** and **D39** are for Aoba only

MV Main ventilators

Q5 (kit parts)

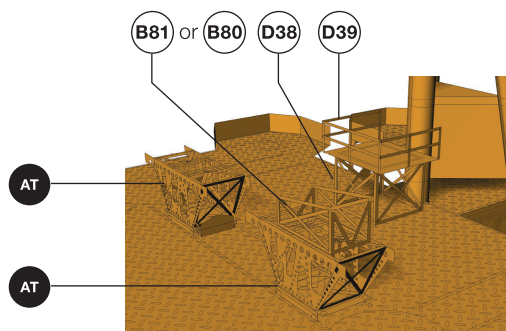
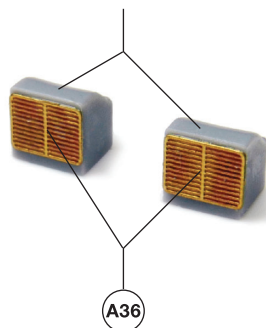

CAT Catapults

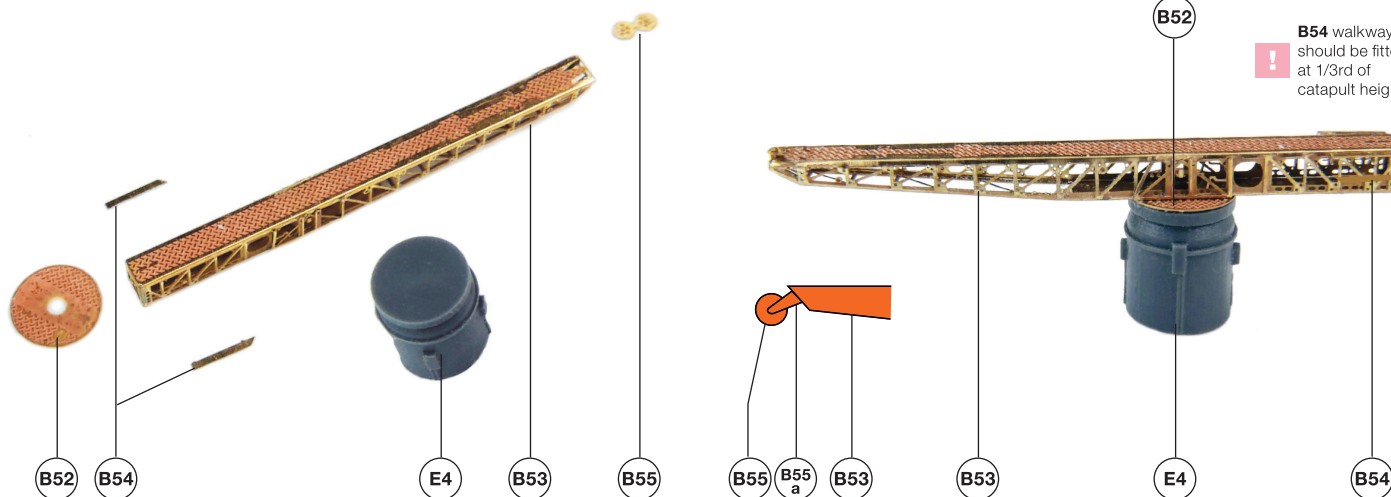

! **B54** walkways should be fitted at 1/3rd of catapult height

SO70024

1/700 IJN Kinugasa 1942 / Aoba 1945

Premium Detail Set for Hasegawa kits (cat nos. 43169 and 43166)

MM main mast

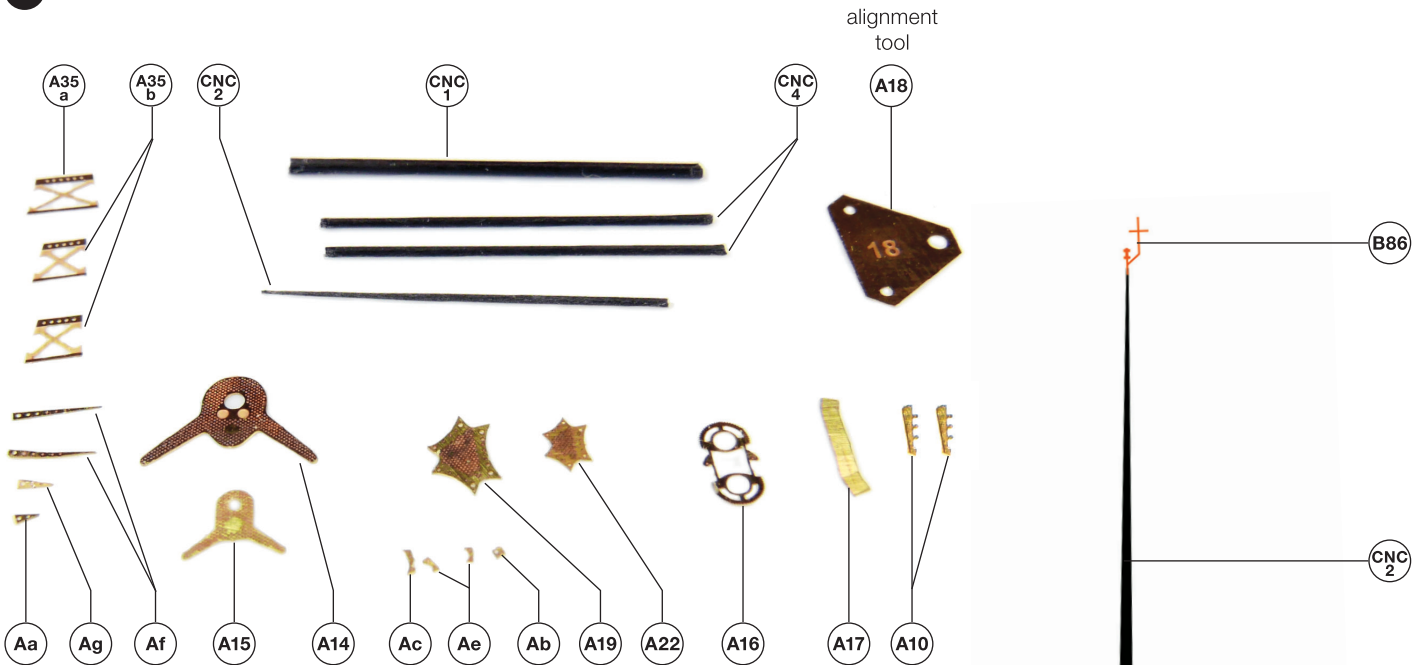

Bottom view of both main mast's platforms – support placement guide

LP lower platform

UP upper platform

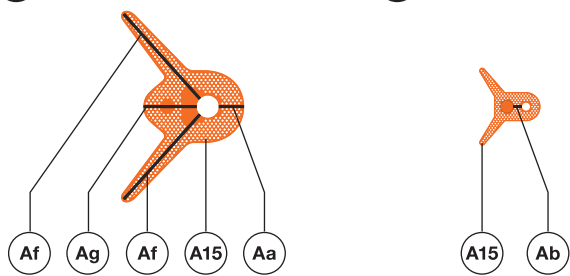

Location of the signal lines supports on the main mast.

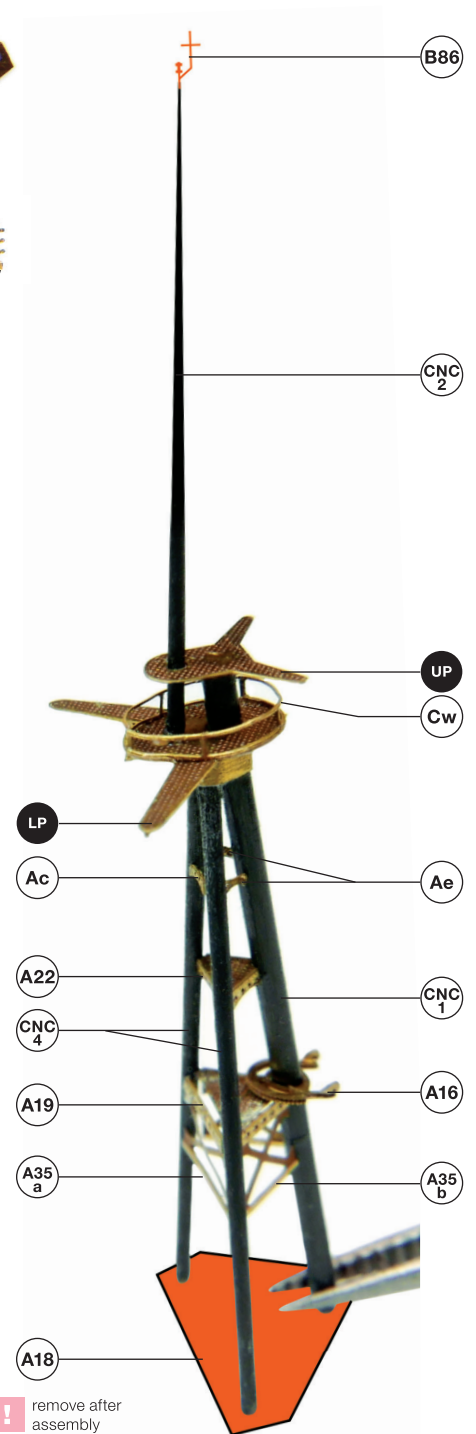



designed by blacman

Shelf Oddity

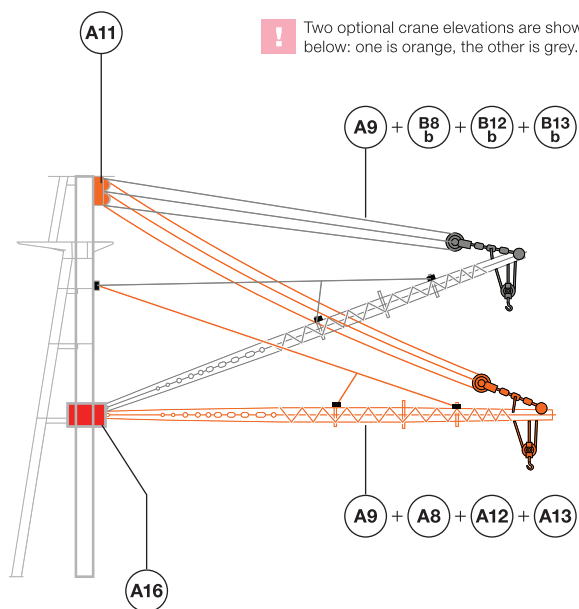
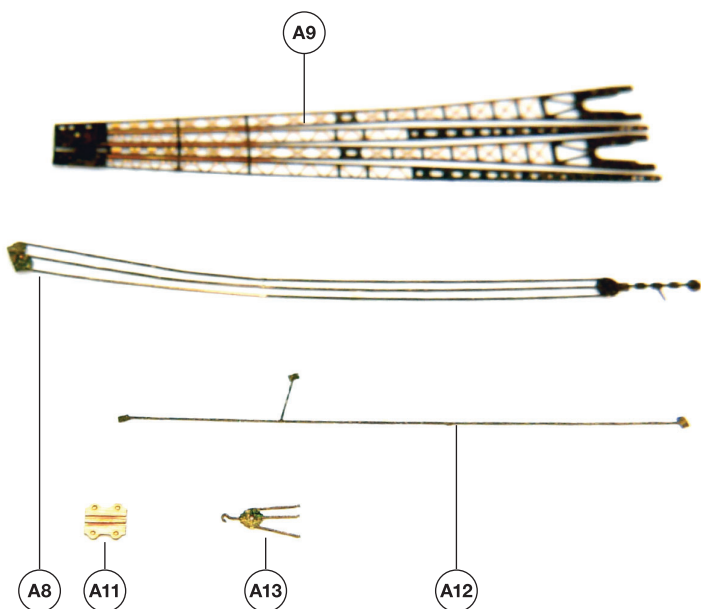

! Two optional crane elevations are shown below: one is orange, the other is grey.

! Another variant of the orange crane elevation is shown below. Check your references please.

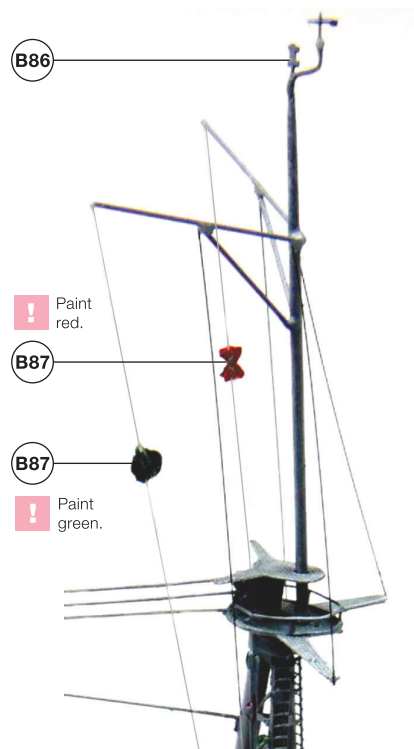
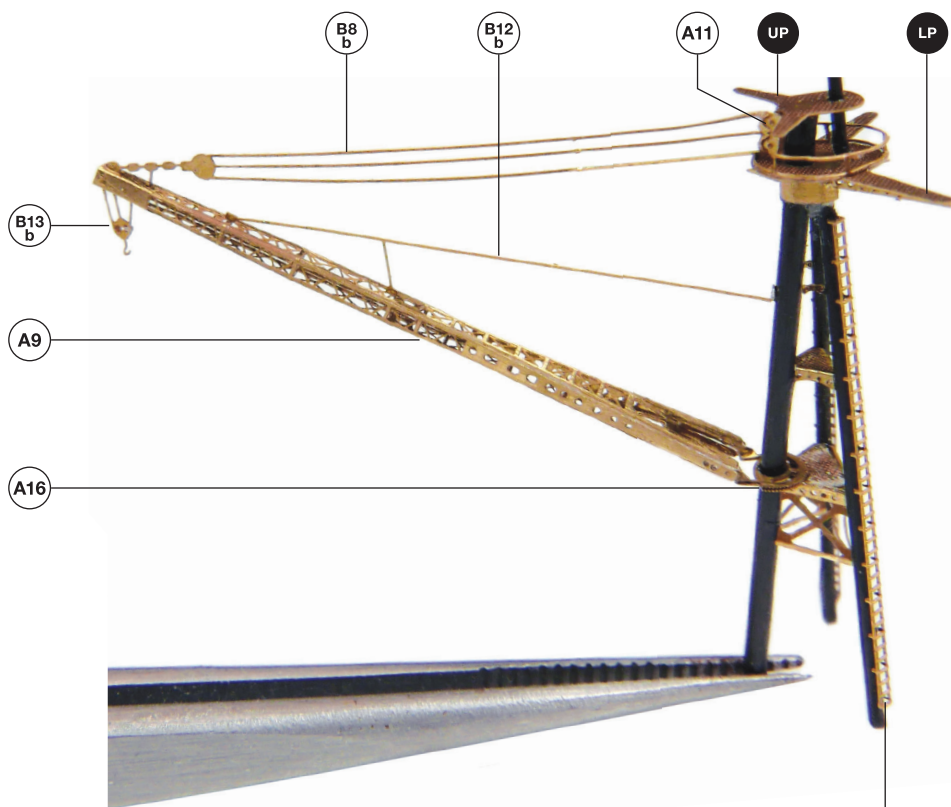

D61 ! Ladder on starboard leg only!

SO70024

1/700 IJN Kinugasa 1942 / Aoba 1945

Premium Detail Set for Hasegawa kits (cat nos. 43169 and 43166)

MT AG main gun turrets and AA armament

MT 203 mm main guns

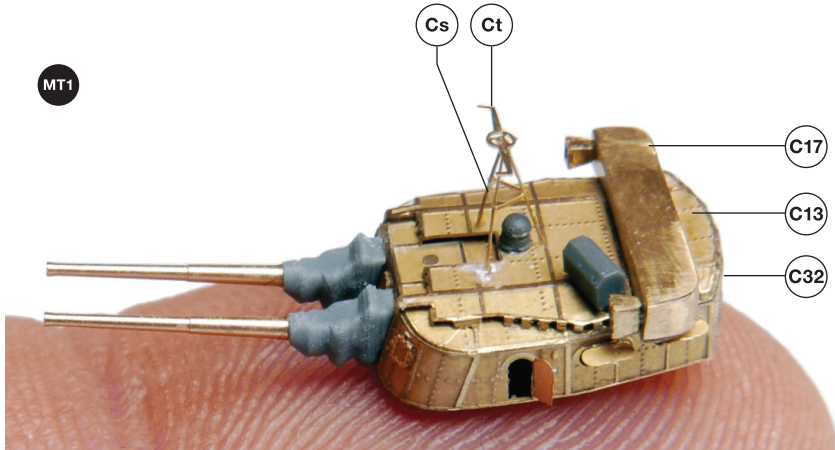
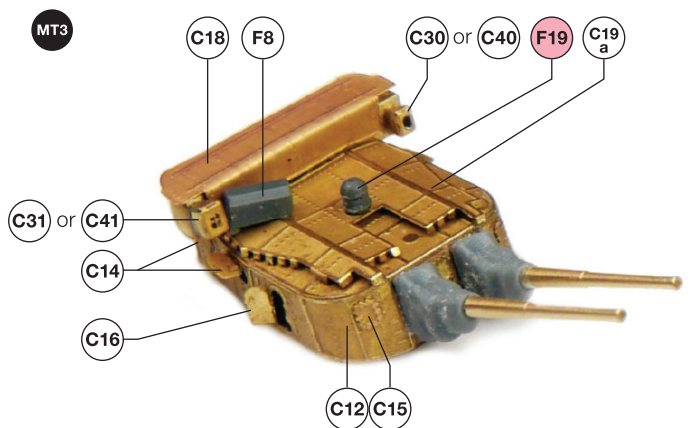
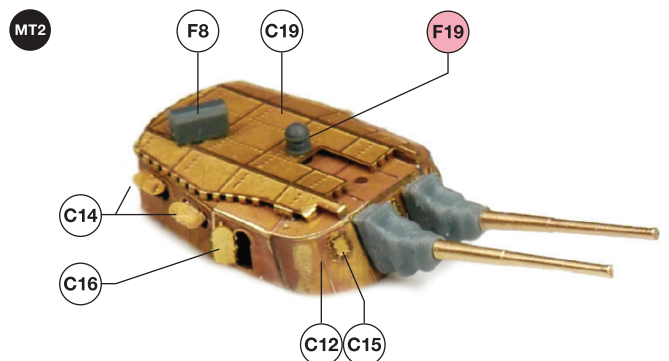
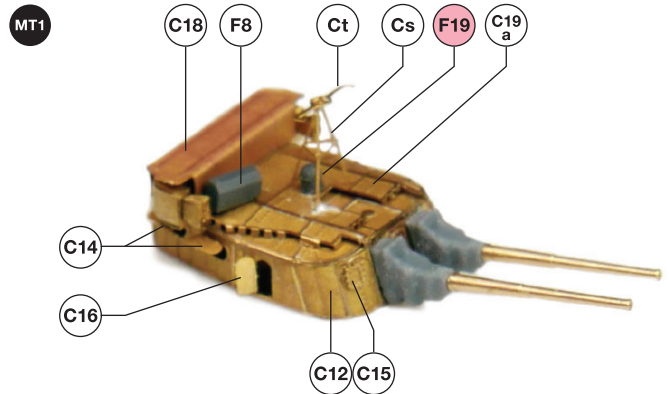
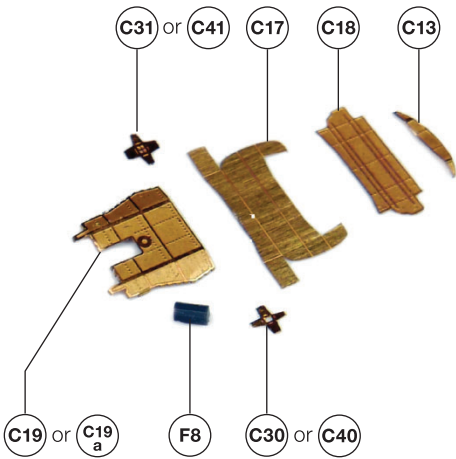
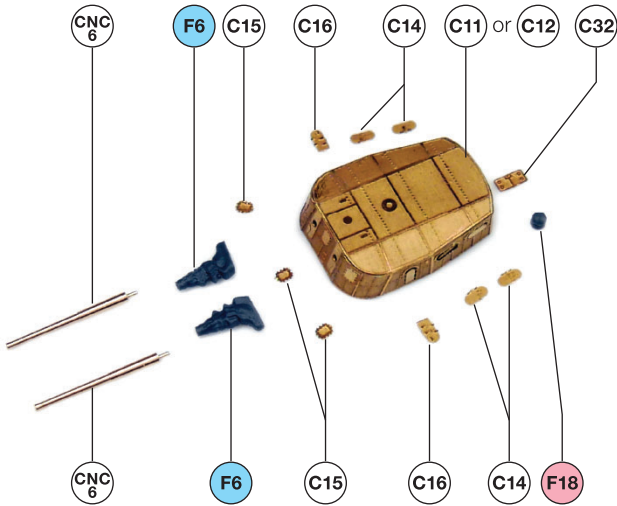

! Rangefinder is shown here without sun cover.

! The doors are on the rear side of the turret.

! Rangefinder viewports guide:
IJN Kinugasa – C30 and C31
IJN Aoba – C40 and C41



Shelf
Oddity

designed by blacman

AG1 120 mm type 10 Nendo Shiki B2 AA guns

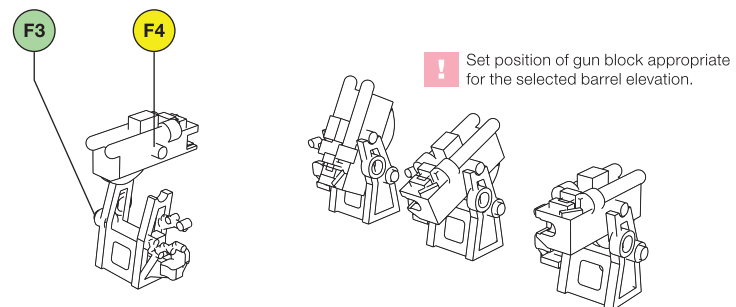
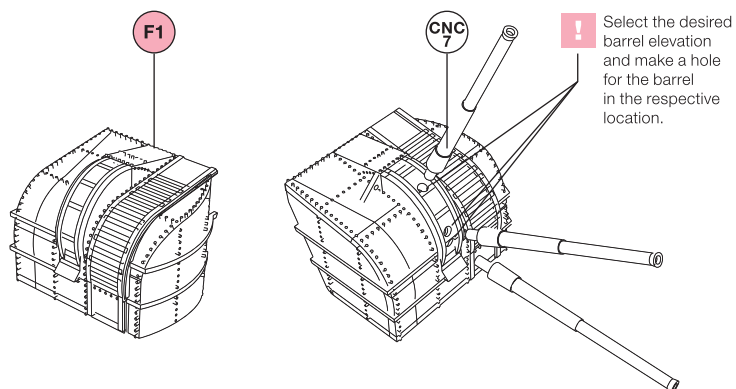

Slide the assembled gun block and support into the blast cover.

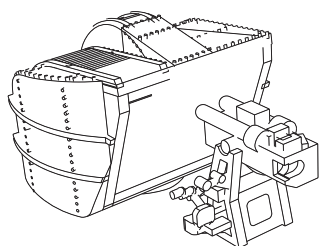

AG2 AG3 Double and triple 25 mm AA guns

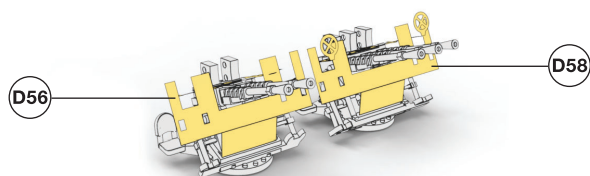
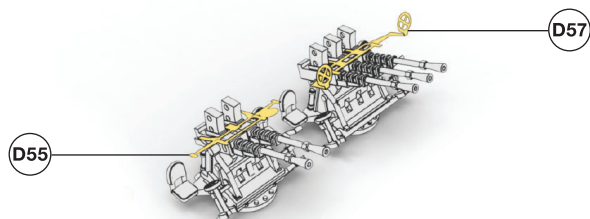
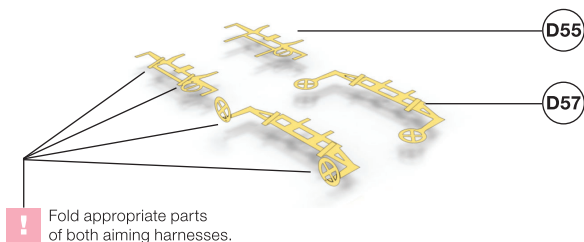
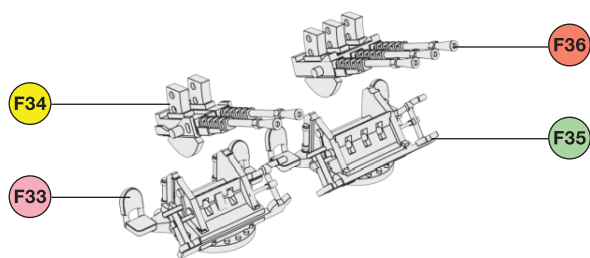

Blast covers were not used in 1942 configuration.

Additional triple 25 mm guns can be purchased separately as SO700122 set.

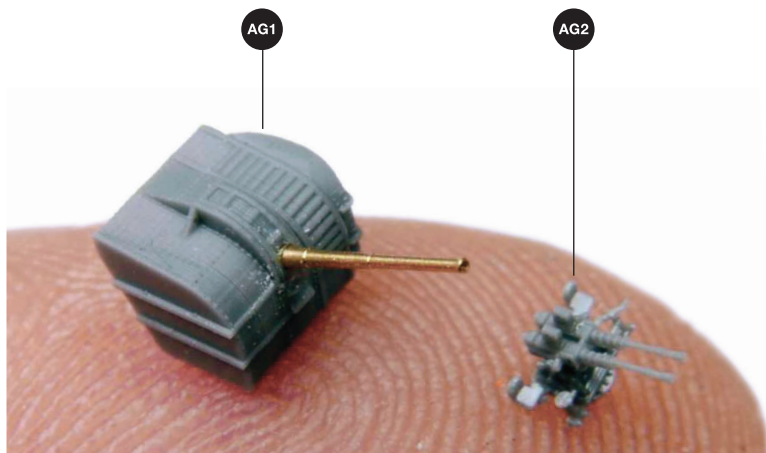

SO70024

1/700 IJN Kinugasa 1942 / Aoba 1945

Premium Detail Set for Hasegawa kits (cat nos. 43169 and 43166)

Boats and aircraft

AC Admiral cutters

! Remove plastic details from the deck of the cutter before application of photoetched parts.

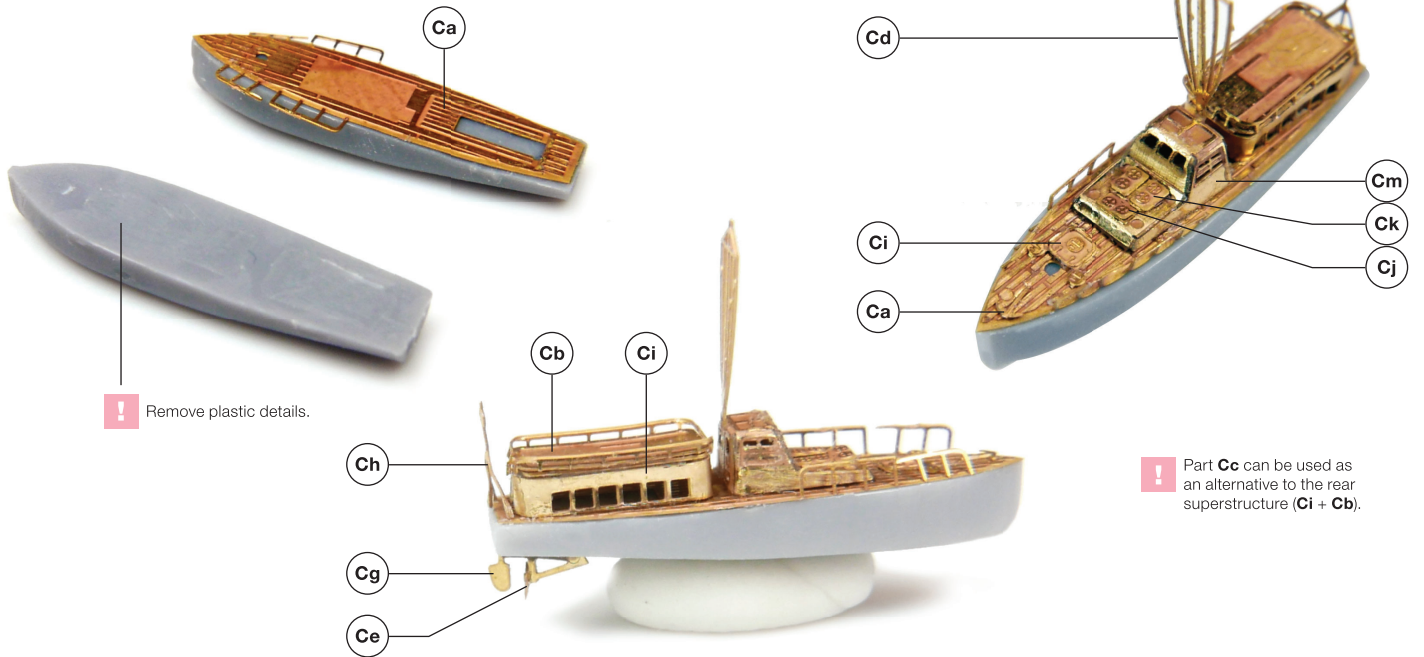

RB1 9 m motor boats

! Remove plastic details from the inside of the boat before application of photoetched parts.





RB2 9 m boats

! Remove plastic details from the inside of the cutter before application of photoetched parts.

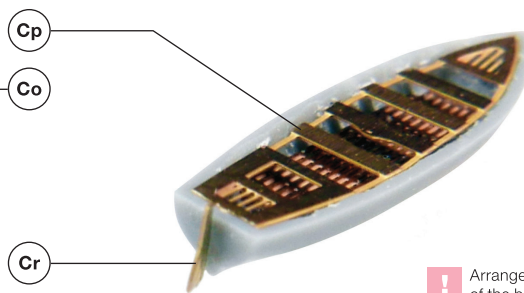
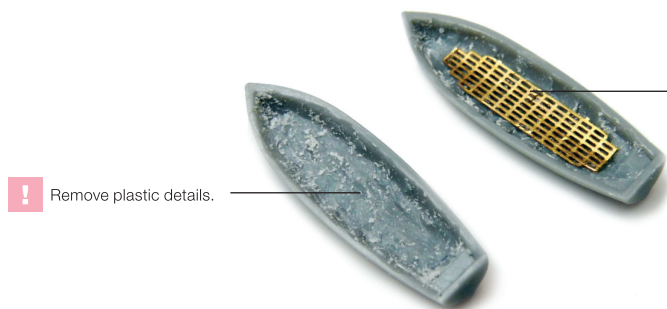

! Arrange the paddles **Cn** inside of the boat or on its benches.

Aichi E13A1 *Jake*

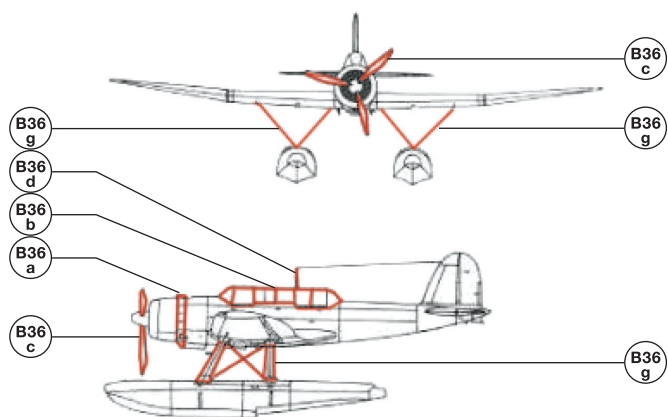

Mitsubishi F1M2 *Pete*

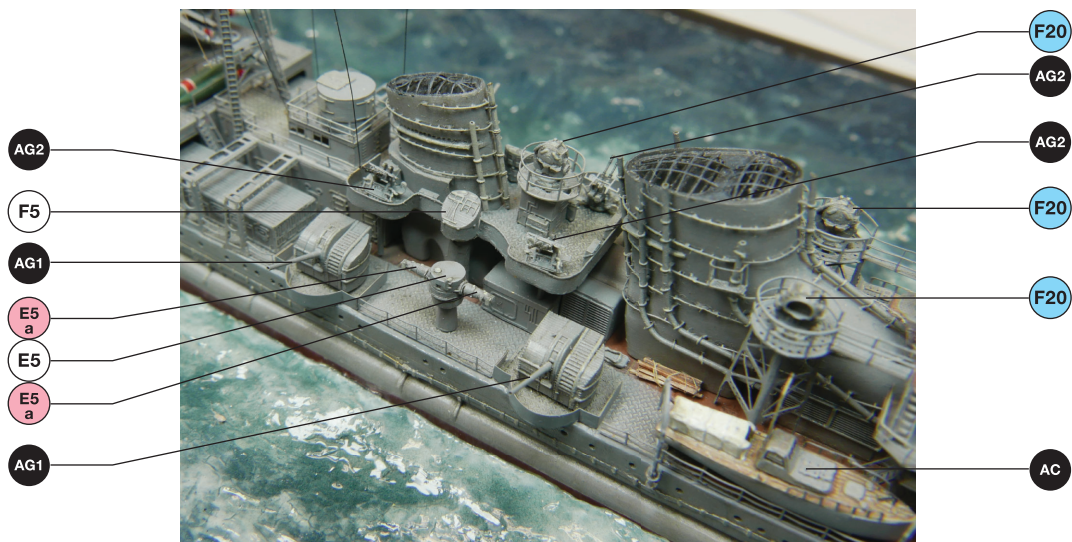
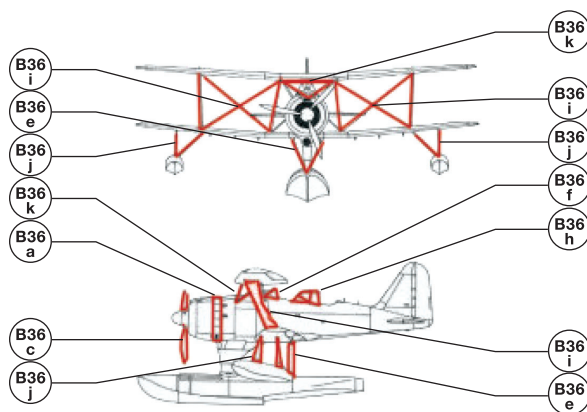

SO70024

1/700 IJN Kinugasa 1942 / Aoba 1945

Premium Detail Set for Hasegawa kits (cat nos. 43169 and 43166)

IJN Aoba 1945 section plan and deck fittings:

! This scheme shows only IJN Aoba 1945 special features.
The placement of items not shown here is identical as shown on pages 4-5 (IJN Kinugasa 1942.)

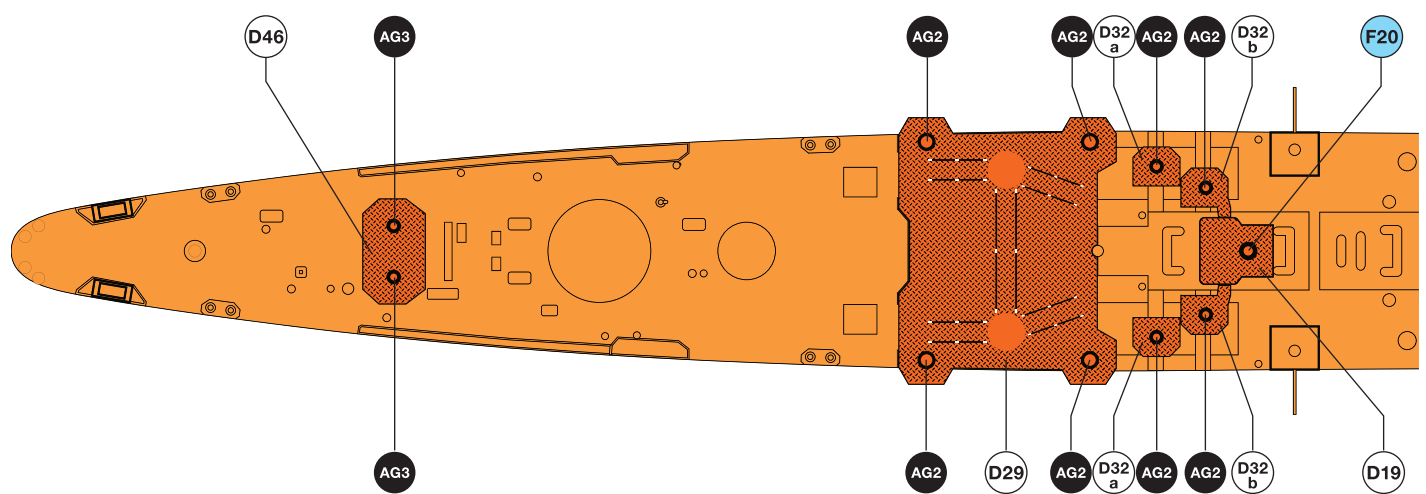
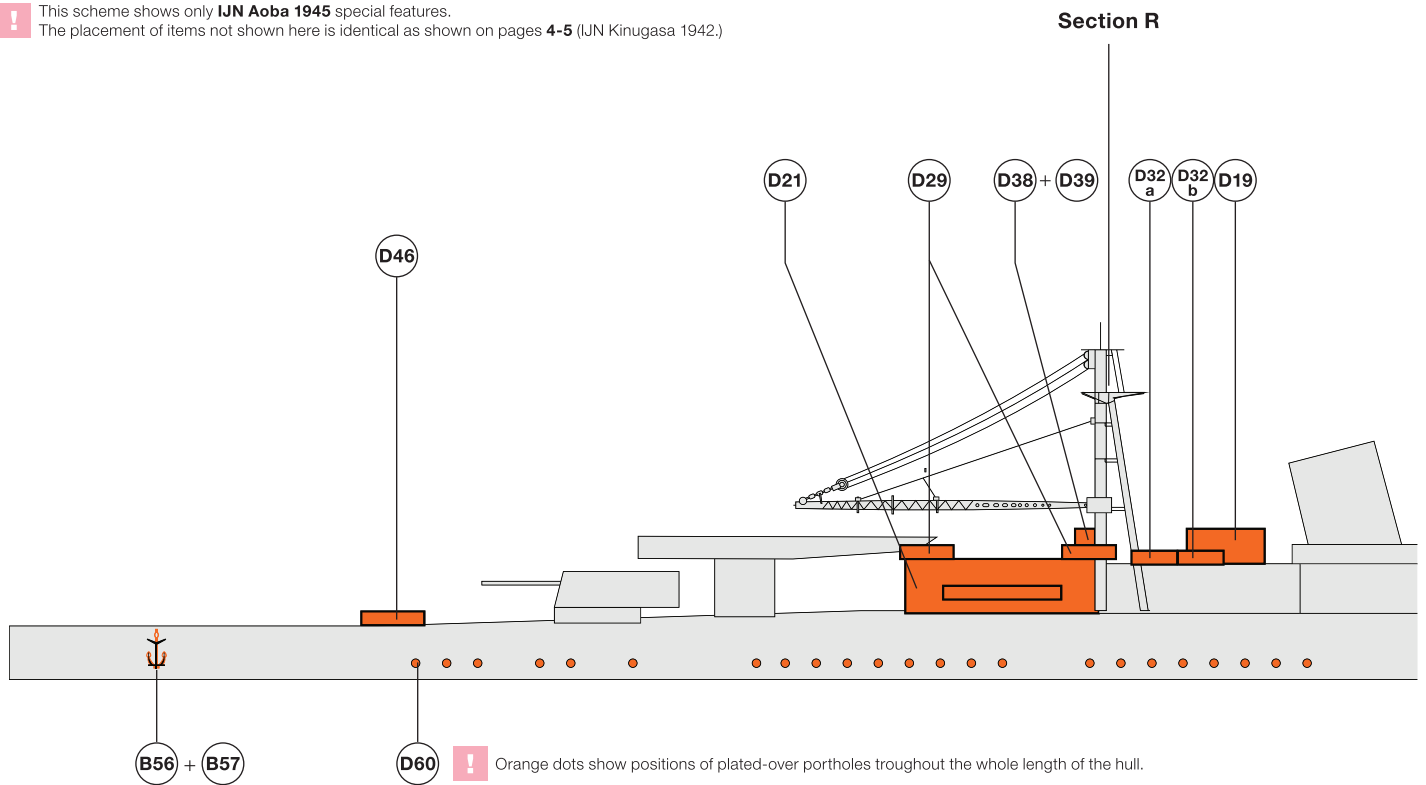



Section S

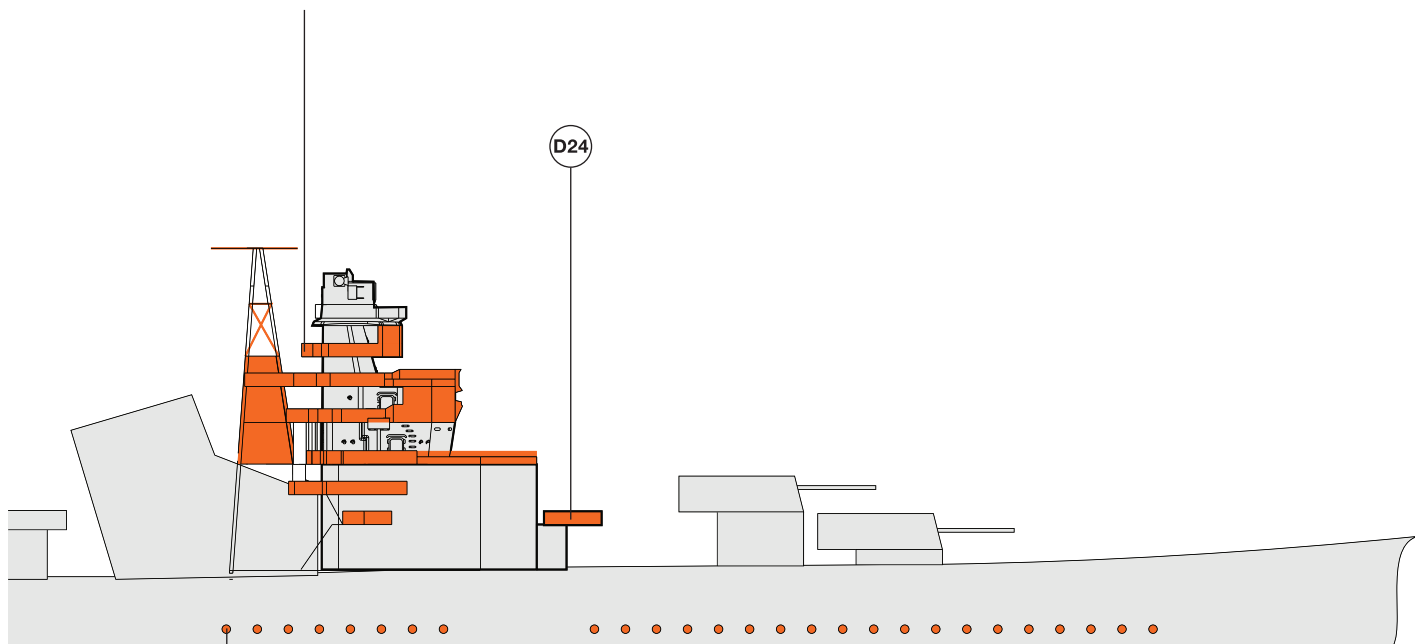

D60 ! Orange dots show positions of plated-over portholes throughout the whole length of the hull.

! Searchlight towers are not present on **IJN Aoba**.

AG2

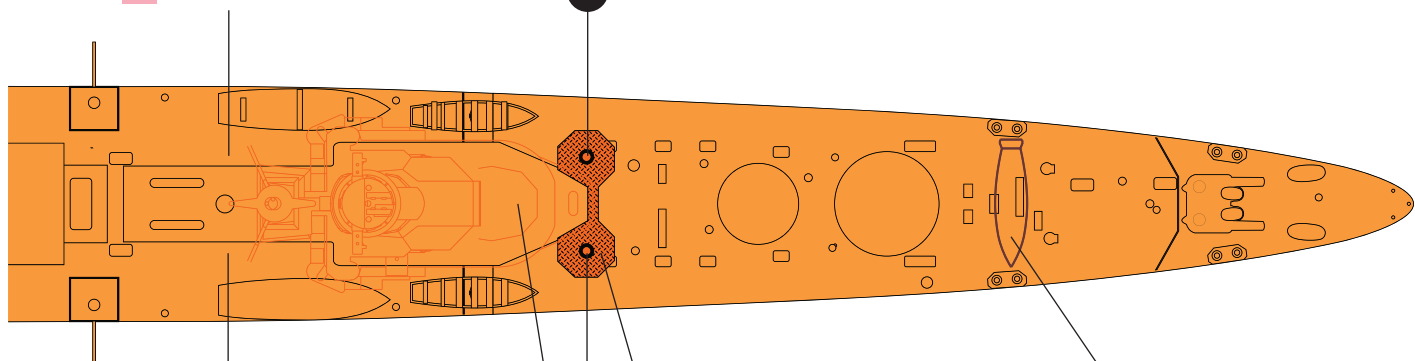

! Searchlight towers are not present on **IJN Aoba**.

AG3

AG2

D24

8 m sampan
IJN Aoba 1945 only

! Can be purchased separately as **SO700154** set.

SO70024

1/700 IJN Kinugasa 1942 / Aoba 1945

Premium Detail Set for Hasegawa kits (cat nos. 43169 and 43166)

Section S – bridge and foremast area:

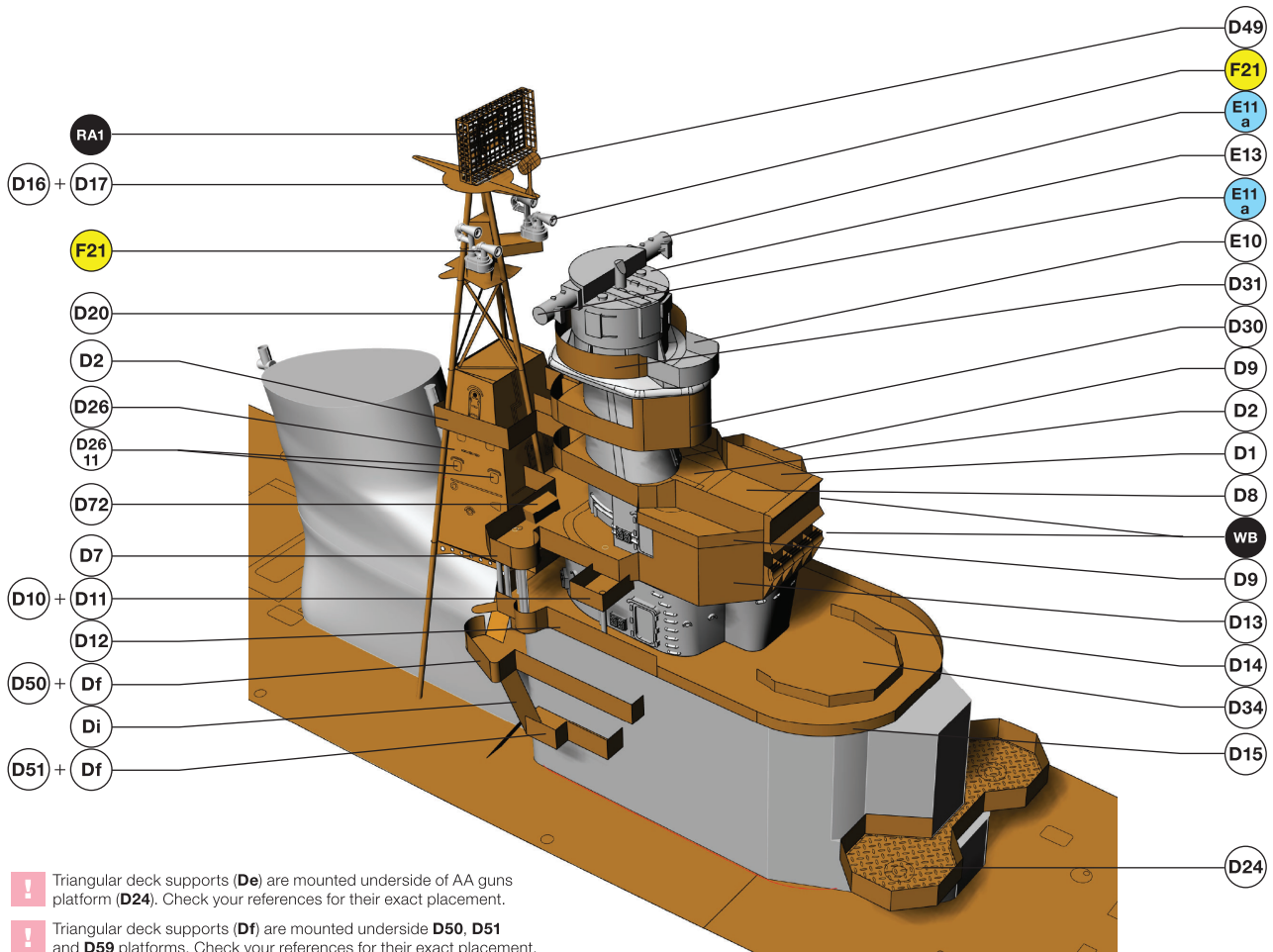

RA1 21 GO Dentan KAI 2 air search radar

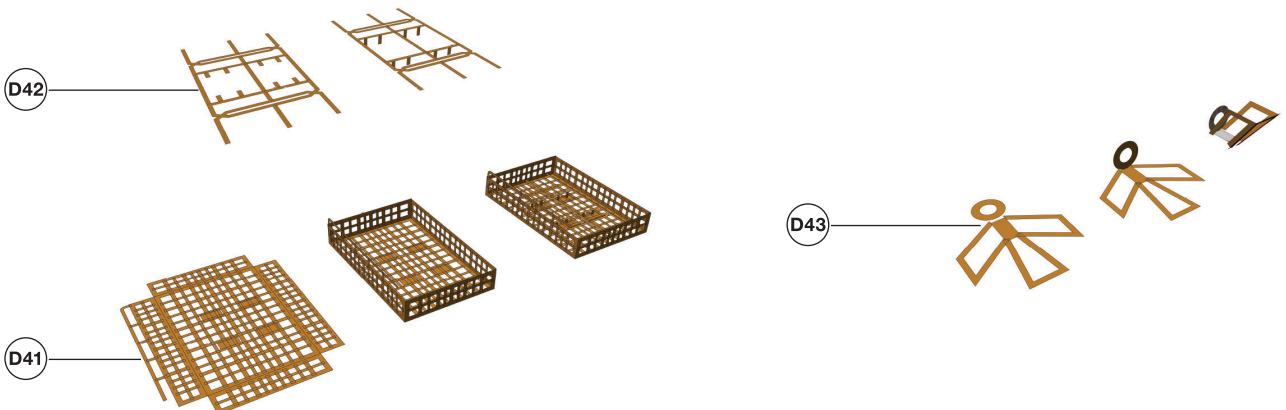

! Parts **D41**, **D42** and **D43** need to be shaped as shown on the above drawing.



designed by blacman

Shelf
Oddity

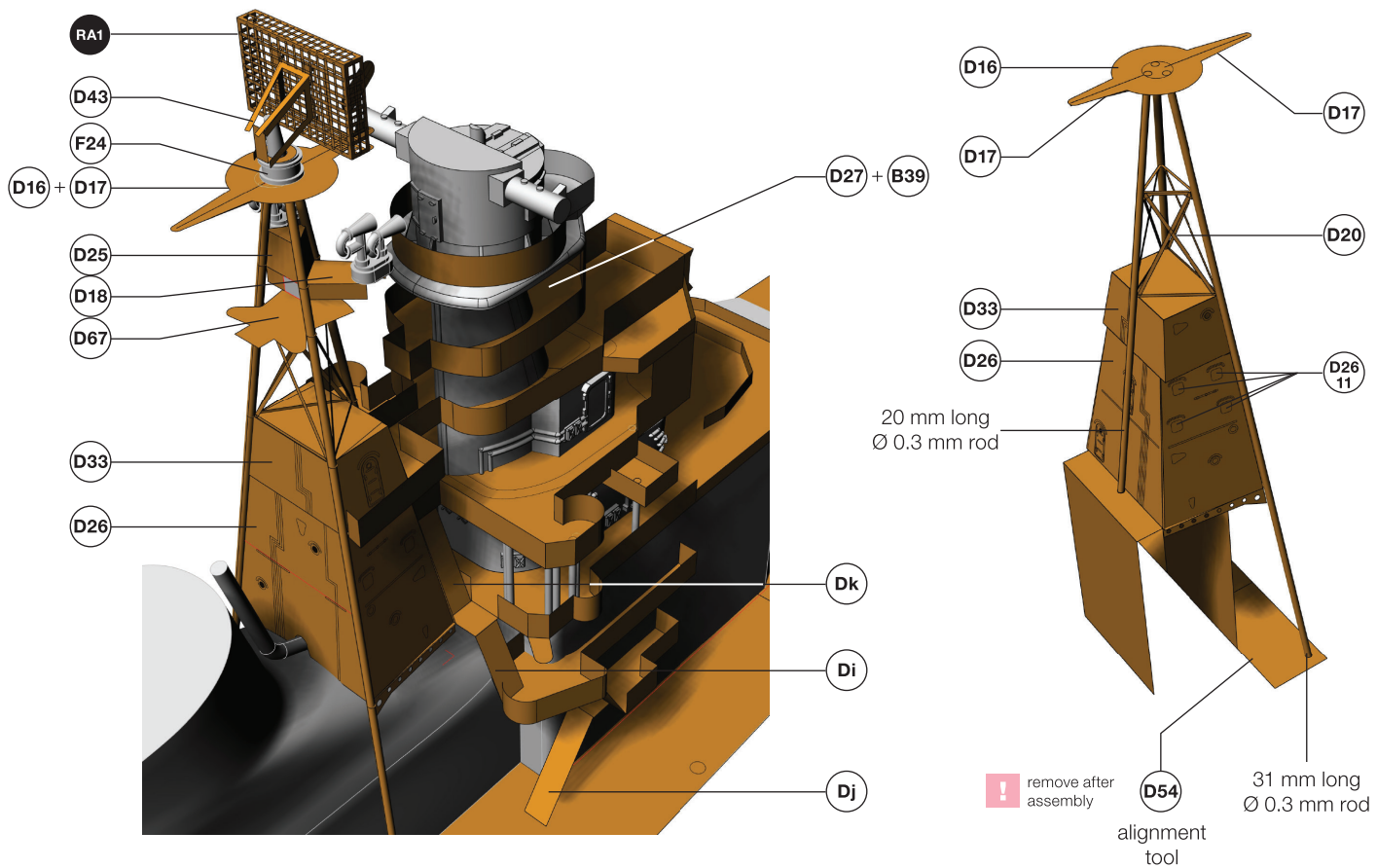

WB Wind baffles mounted on the frontside of the bridge.

Side walkways behind the bridge.

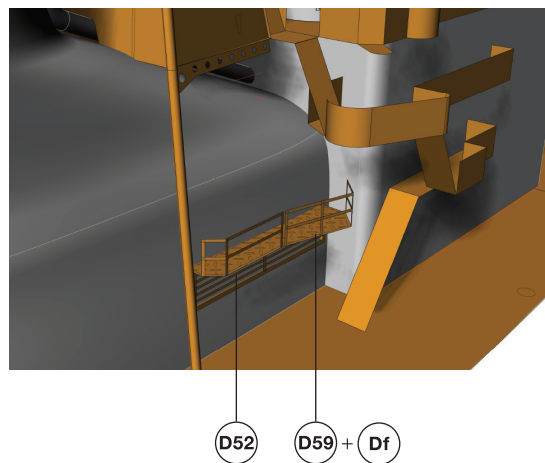
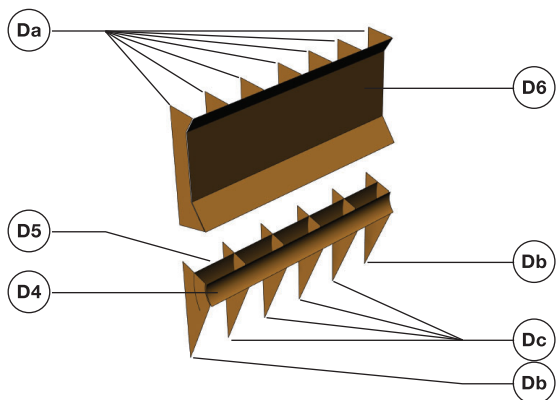

SO70024

1/700 IJN Kinugasa 1942 / Aoba 1945

Premium Detail Set for Hasegawa kits (cat nos. 43169 and 43166)

Section R – rear superstructure and main mast:

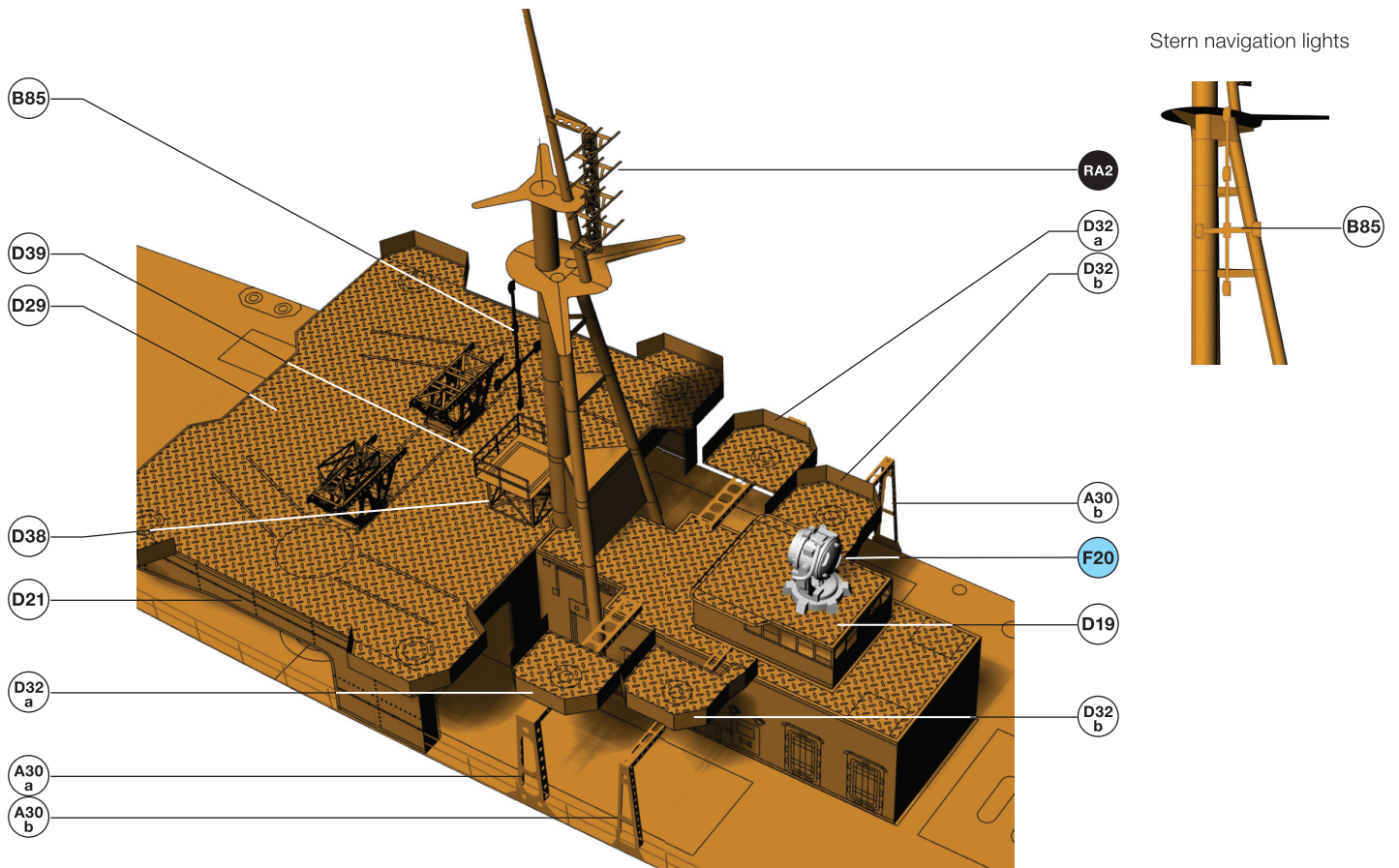

RA2 Tanshingi 3 Gata Type 3 radar

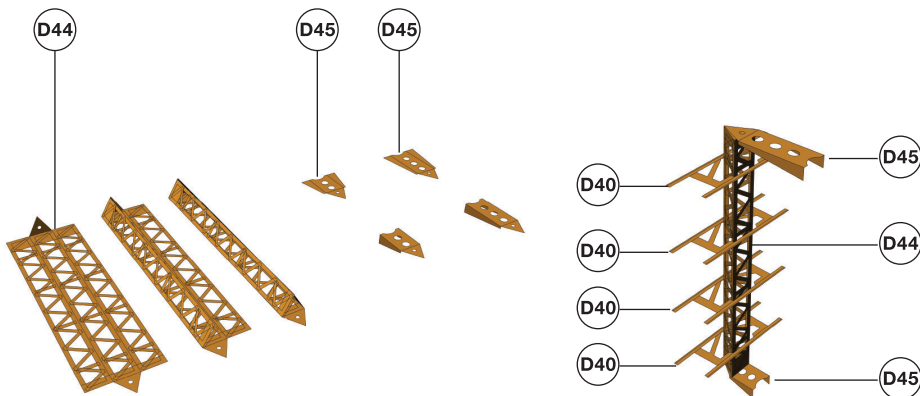

! Parts **D40** and **D45** need to be folded as shown on the above drawing. The longer part **D45** goes on top-, and the shorter one goes to the bottom of the radar assembly.

Bottom view of the hangar deck

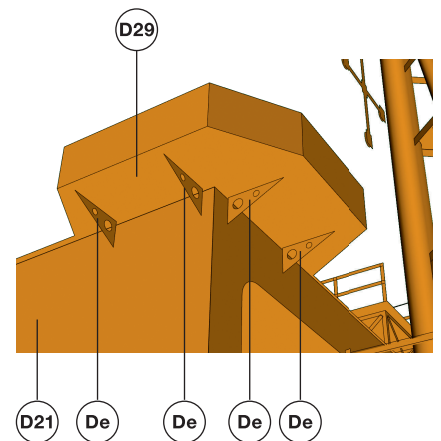

! Layout of the hangar deck supports (**De**) shown here is identical for all four its AA guns platforms.



IJN Kinugasa at 1942

Model done by **Rhayader**: <http://members.upcpoczta.pl/j.bogusz341/Galerie.htm>



SO70024

1/700 IJN Kinugasa 1942 / Aoba 1945 Premium Detail Set for Hasegawa kits



Shelf Oddity

IJN Kinugasa at 1942

Model done by **Rhayader**: <http://members.upcpoczta.pl/j.bogusz341/Galerie.htm>

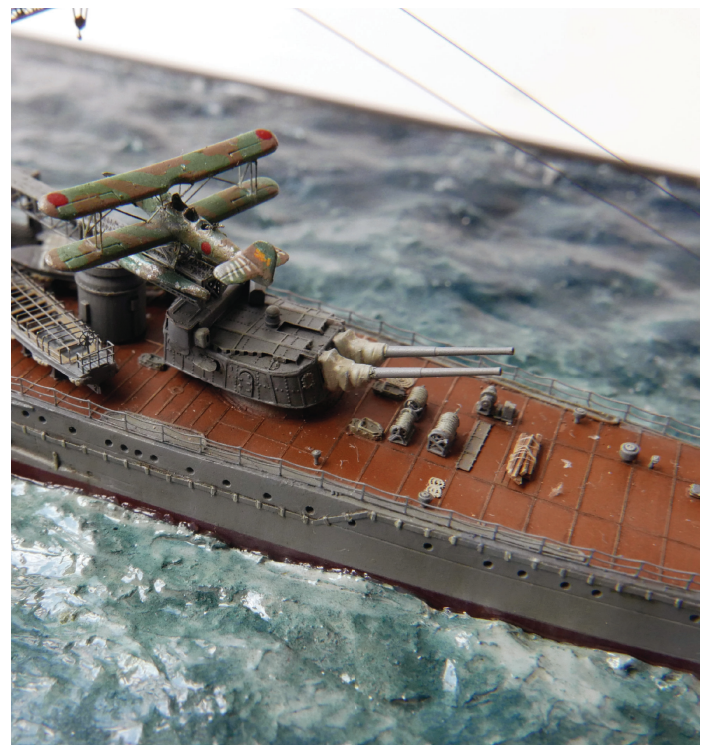

Special *thank you* for great contribution to this project goes to **Rhayader** and **Vladi**. Your job was priceless...