

SO7000015

1/700 IJN Takao class pre-1937 Deck Set for Fujimi kits

Shelf
Oddity



This set is recommended to use with new Fujimi IJN Takao class cruiser kits beginning with no. 40171 plus their further updated releases. The general view of PE fret.

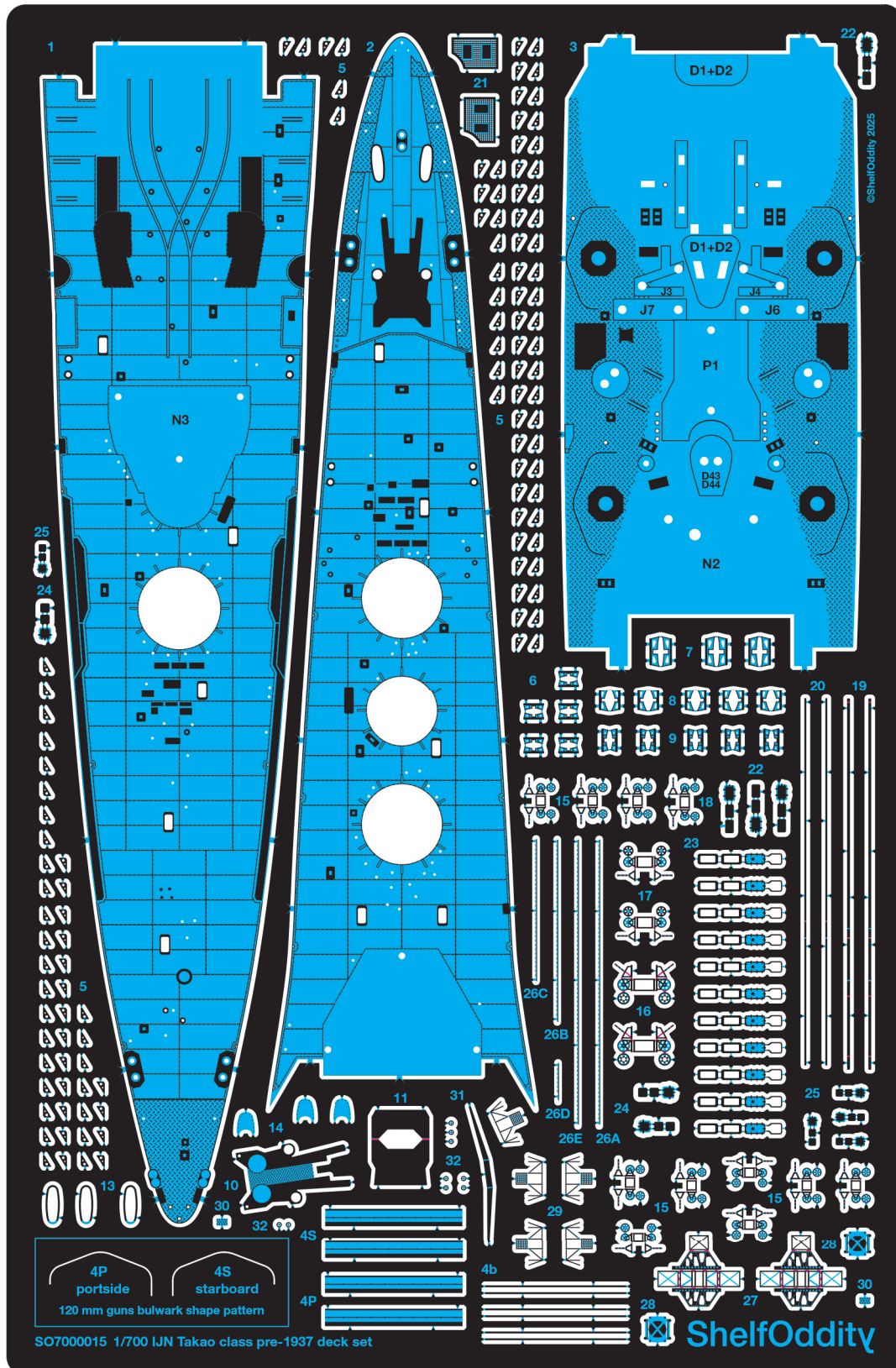



Designed by blaeman

The general view of 3D printed parts

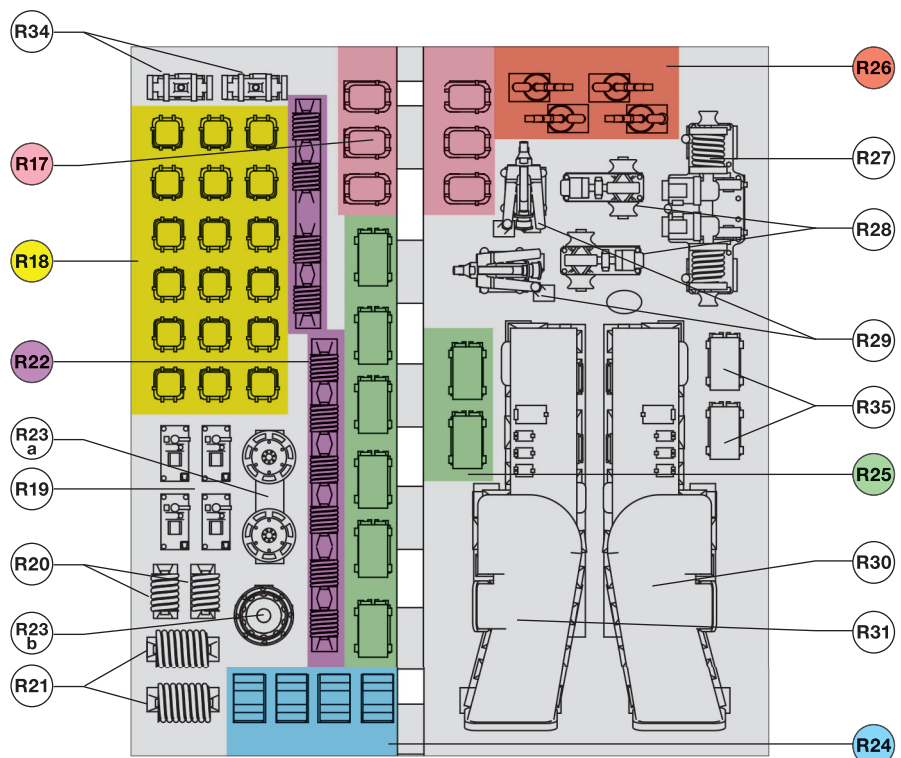
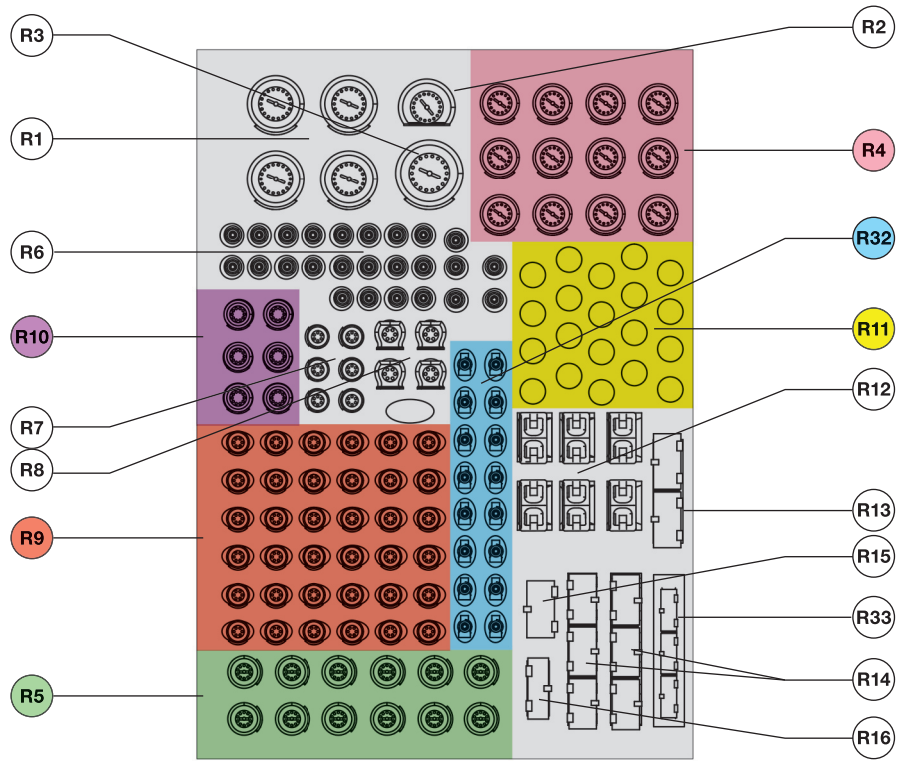



The contents of this manual

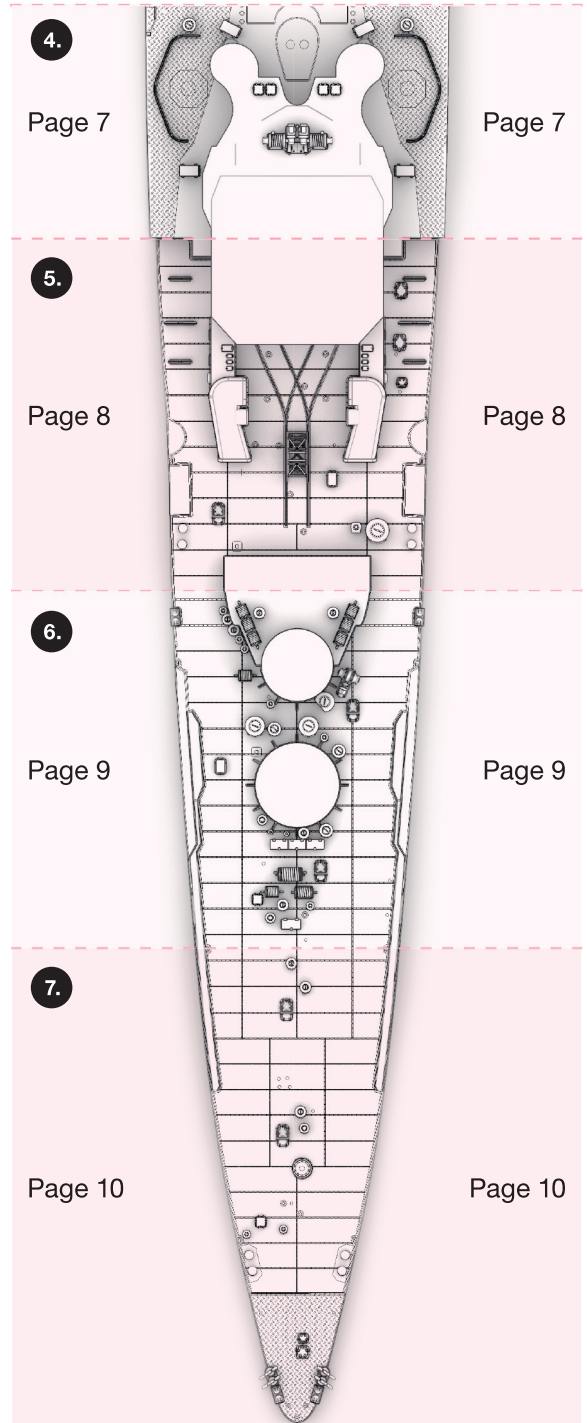
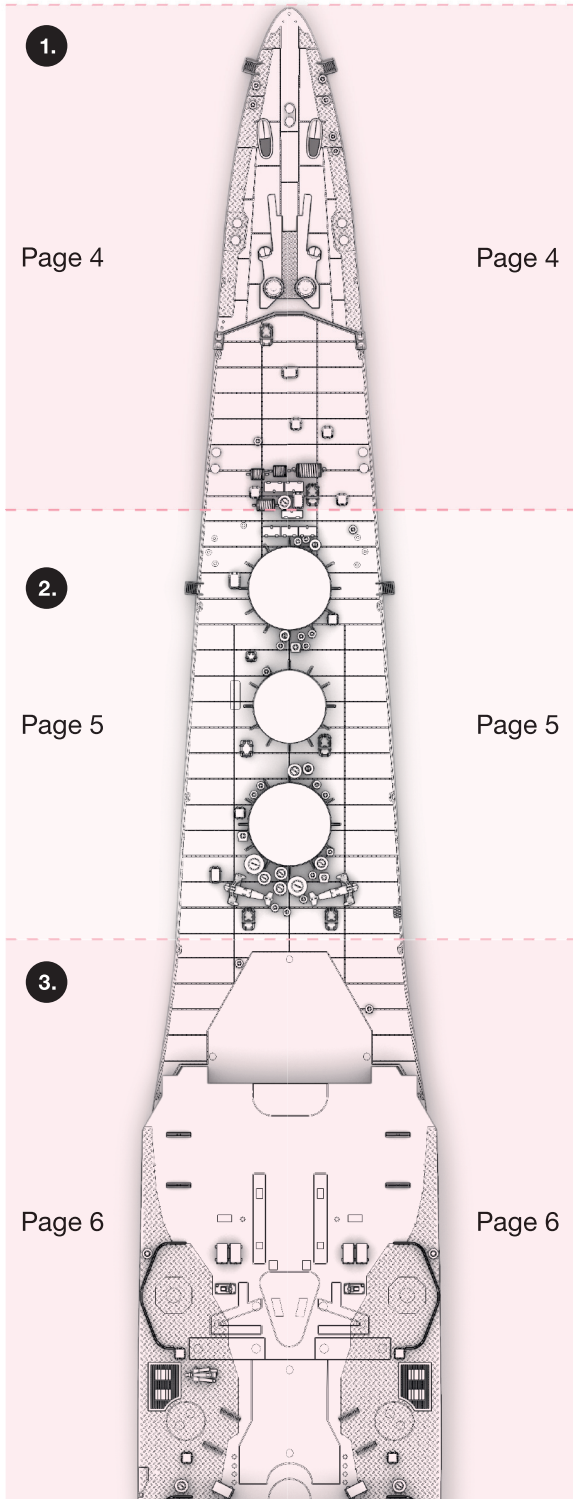



1. Bow section

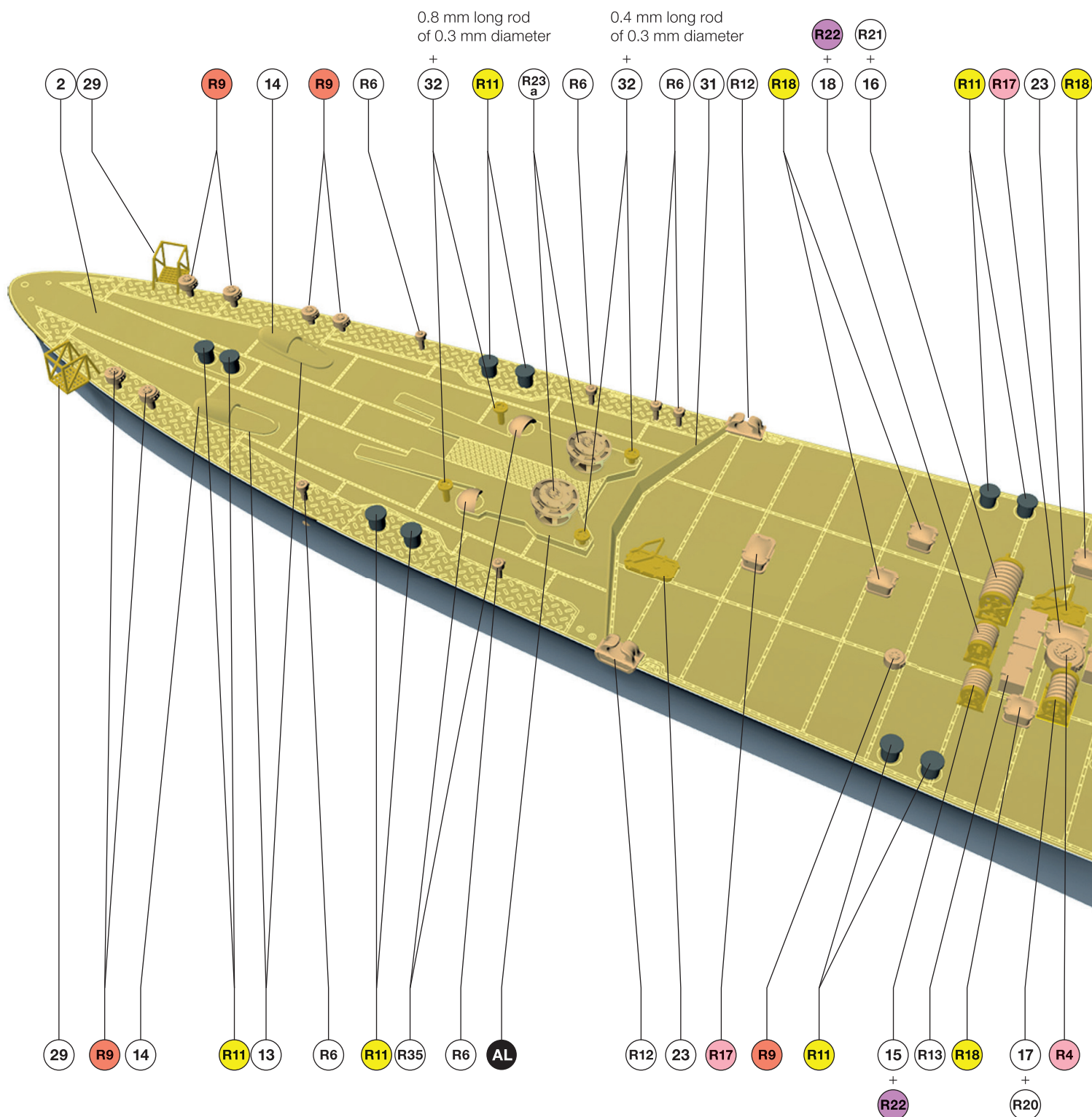



2. Bow section continued – use triangular supports (5) around all main guns barbettes.

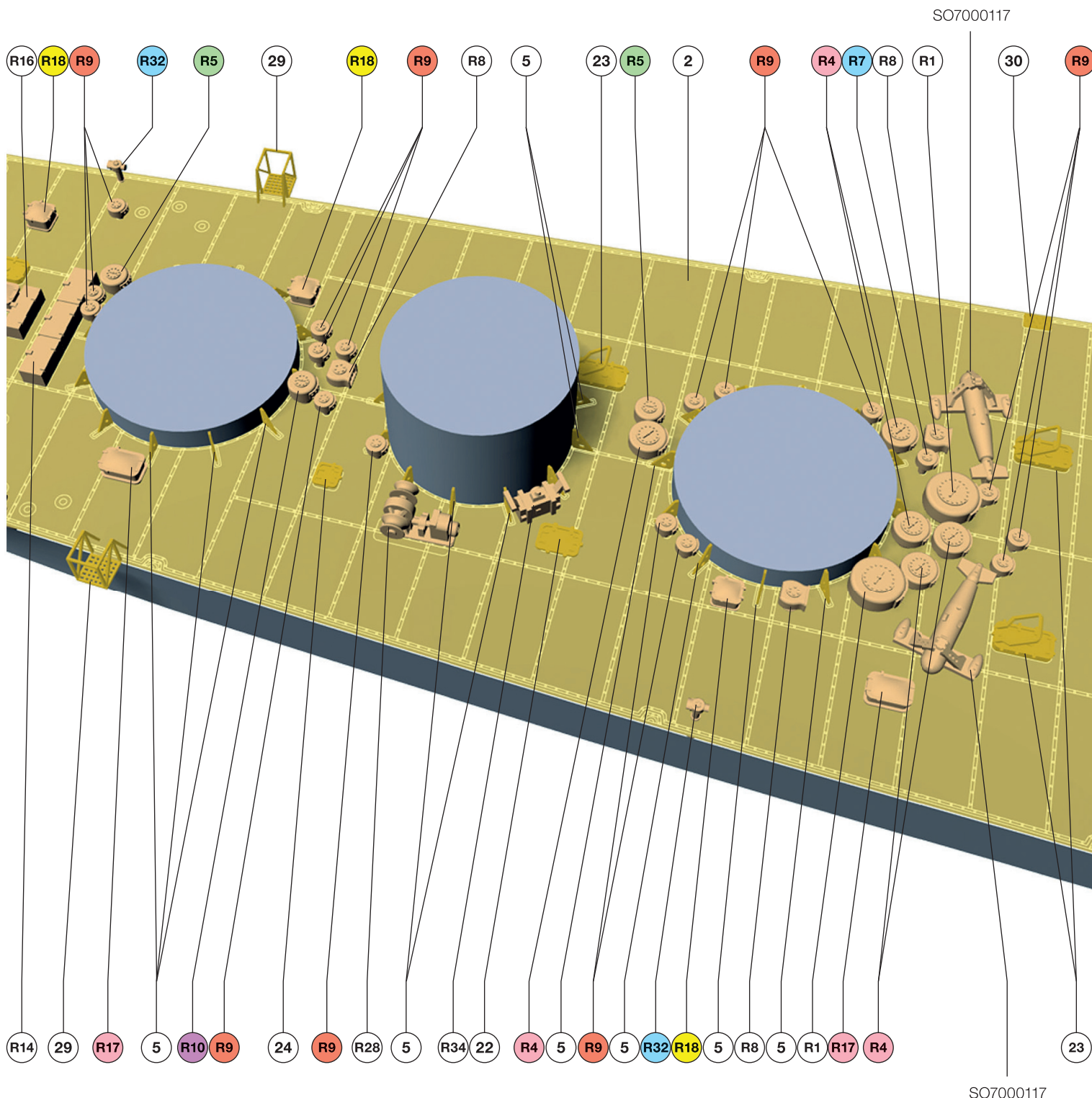

SO7000117



3. Midship section

! Please use your sources in exact positioning of life-boat cradles as these might have been moveable.

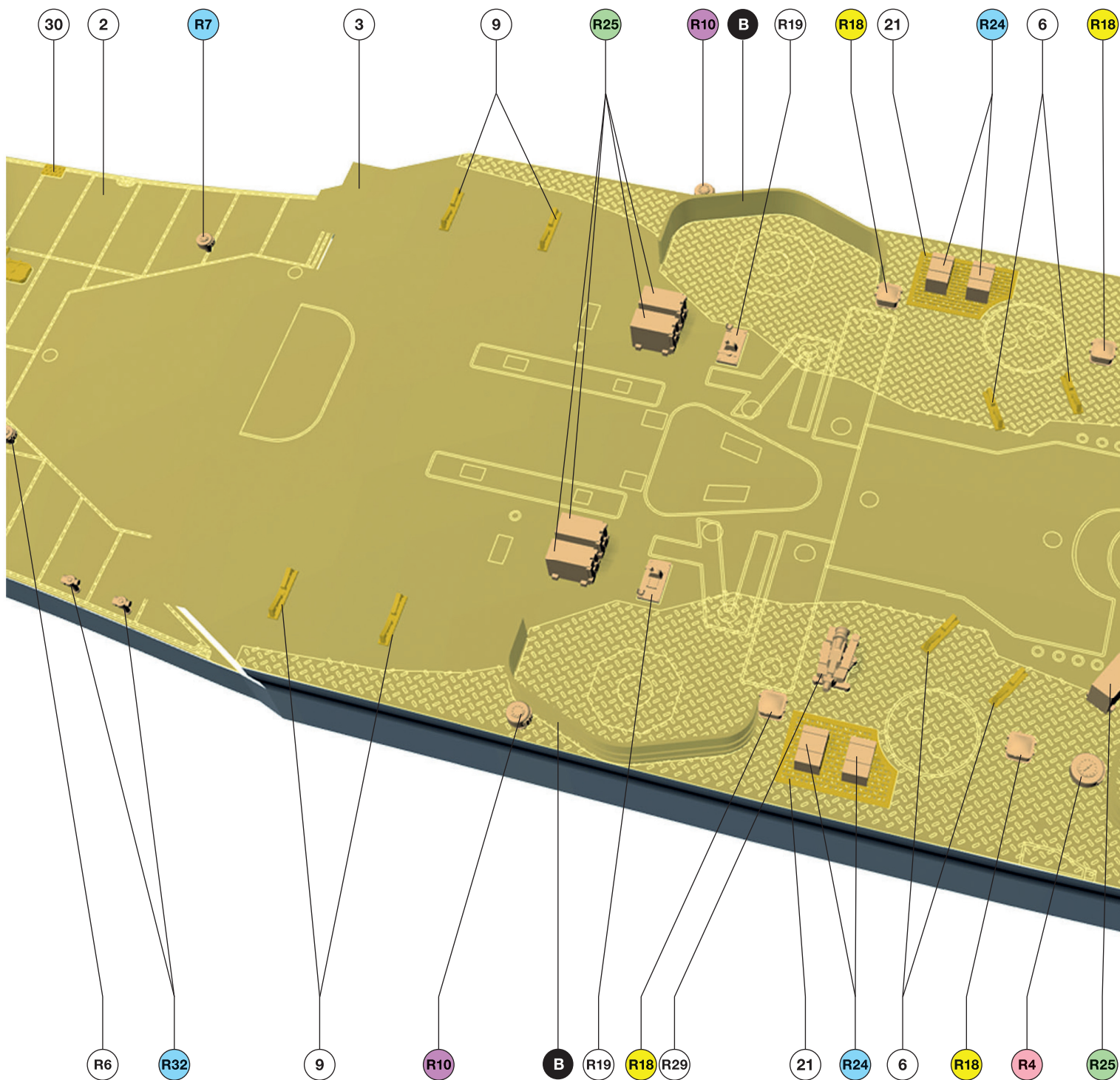



4. Midship section continued

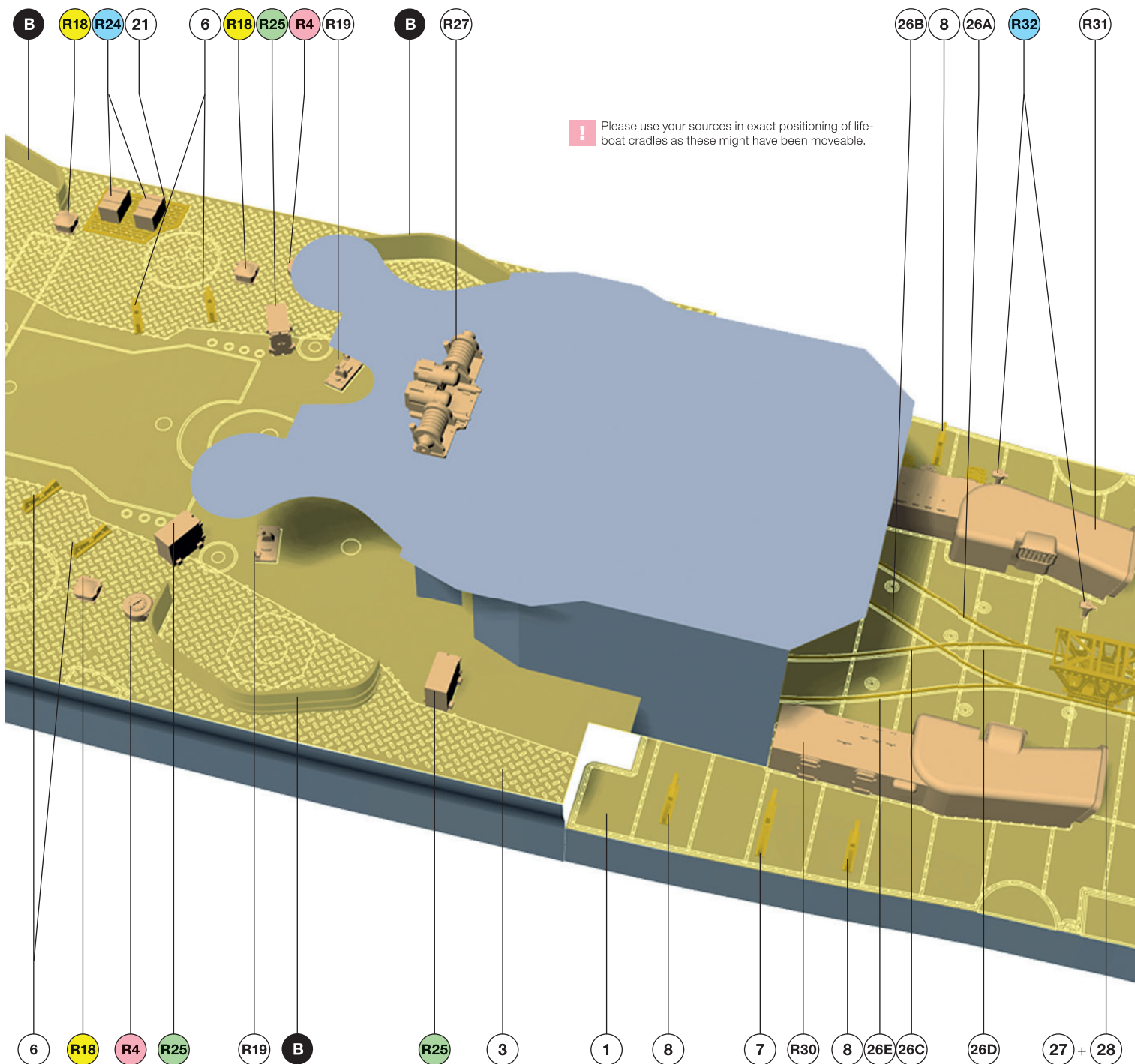



5. Hangar section

! Please use your sources in exact positioning of life-boat cradles as these might have been moveable.

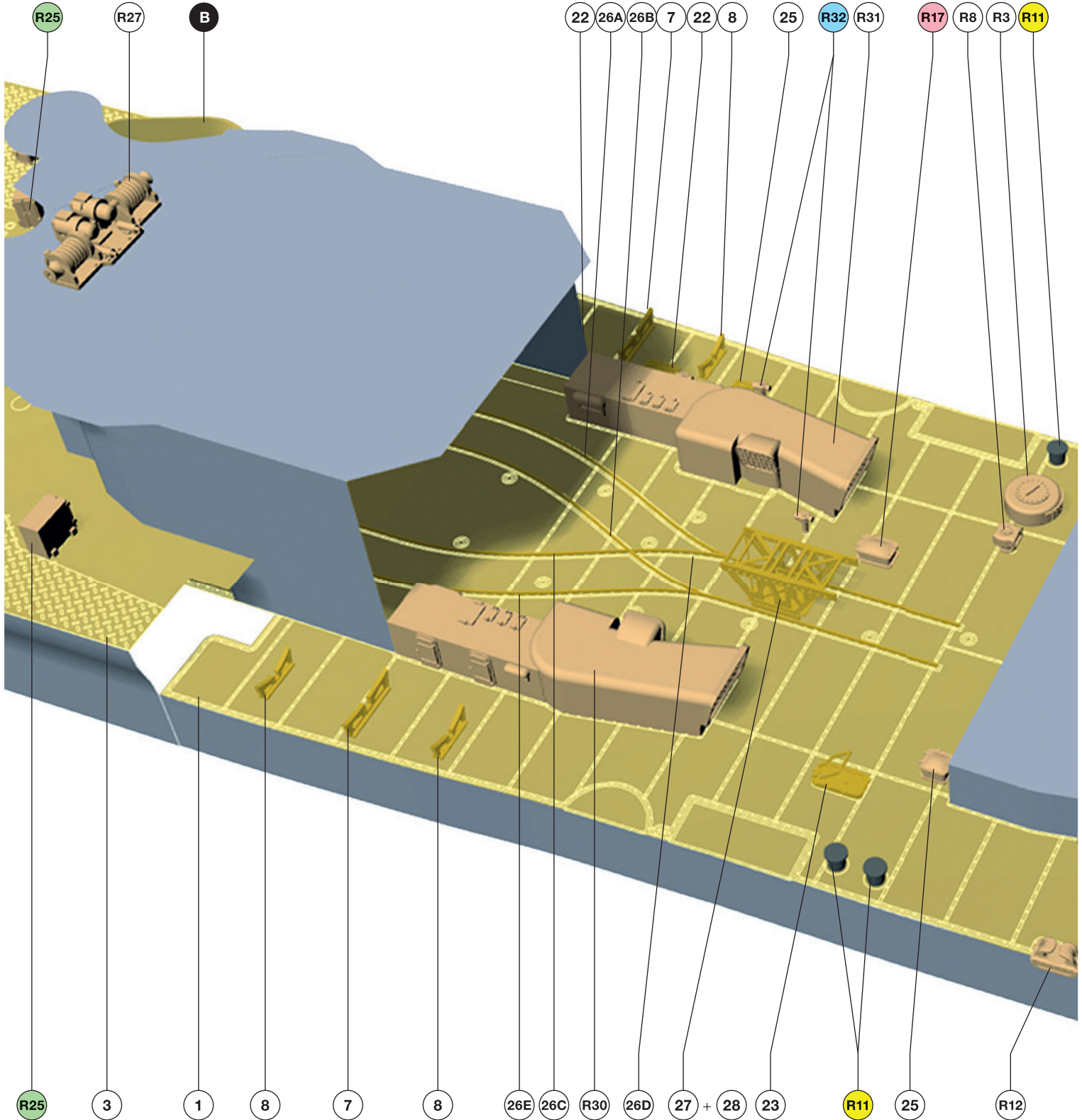



6. Stern section – use triangular supports (5) around all main guns barbettes.

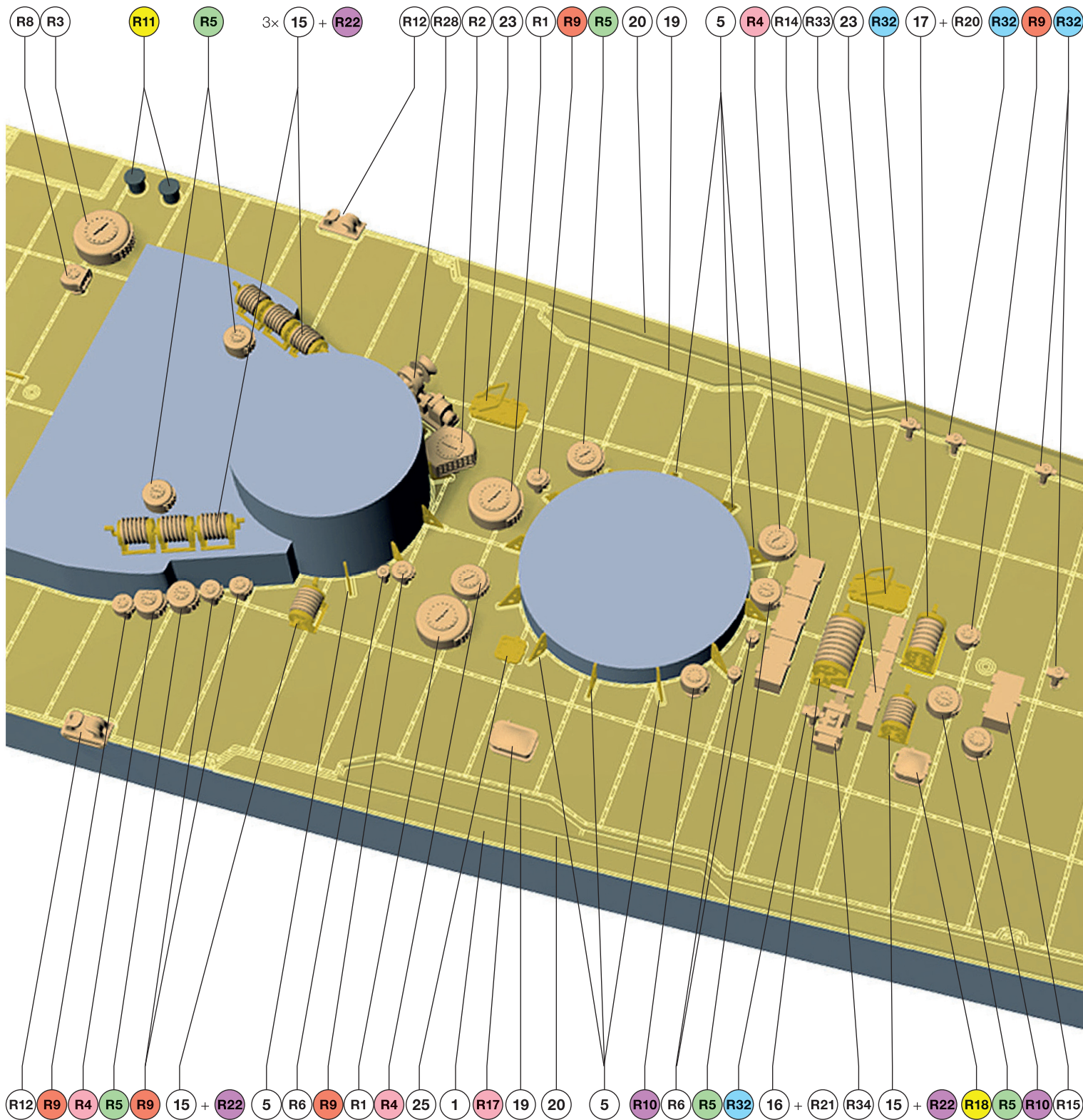

SO7000015

1/700 IJN Takao class pre-1937 Deck Set
for Fujimi kits

Shelf
Oddity



7. Stern section continued

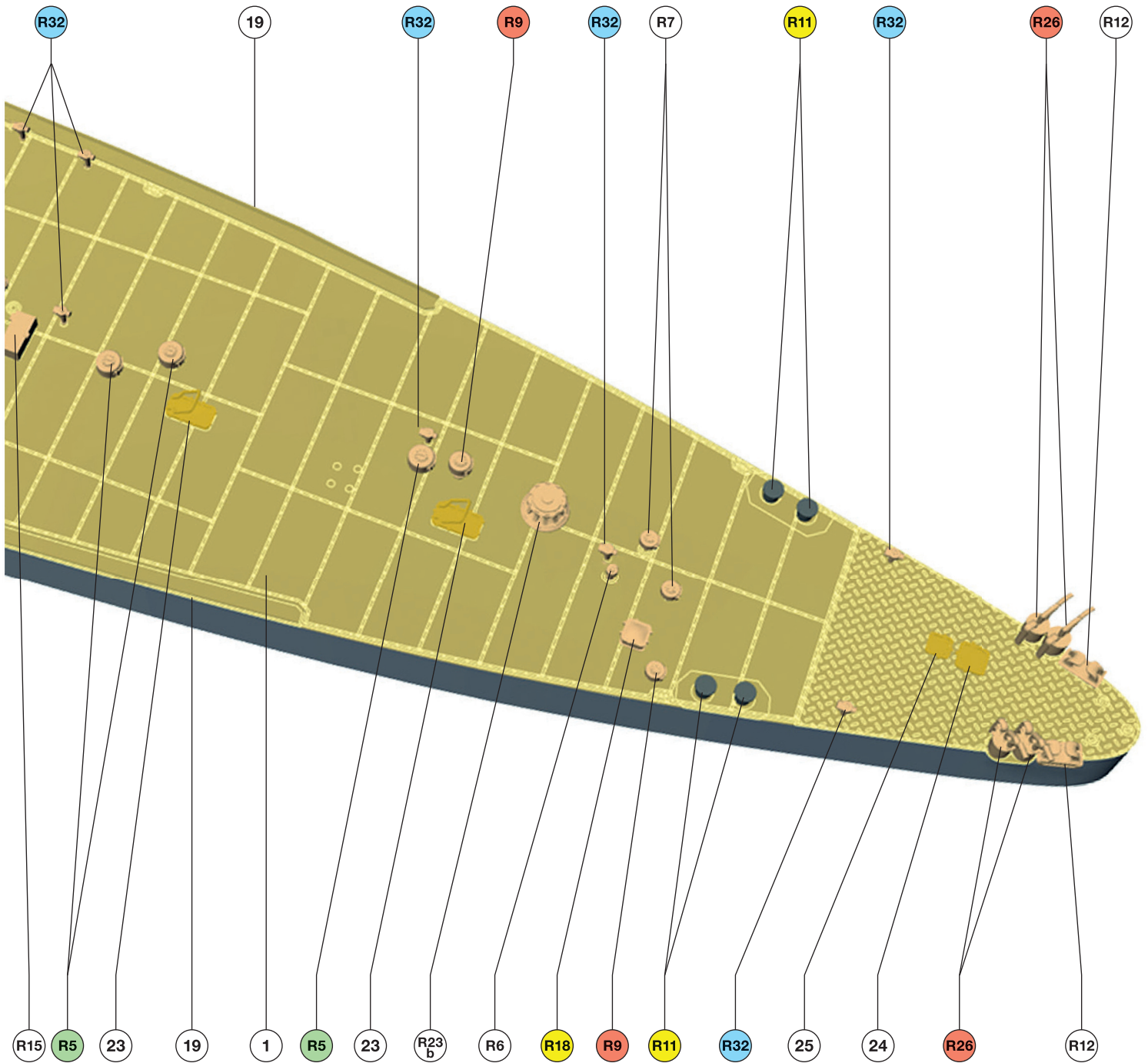



- B** 120 mm guns bulwark assembly – use pattern to shape port side (4P) and starboard (4S), bulwarks. Note: shape parts 4P and 4S first and only then apply parts 4b.

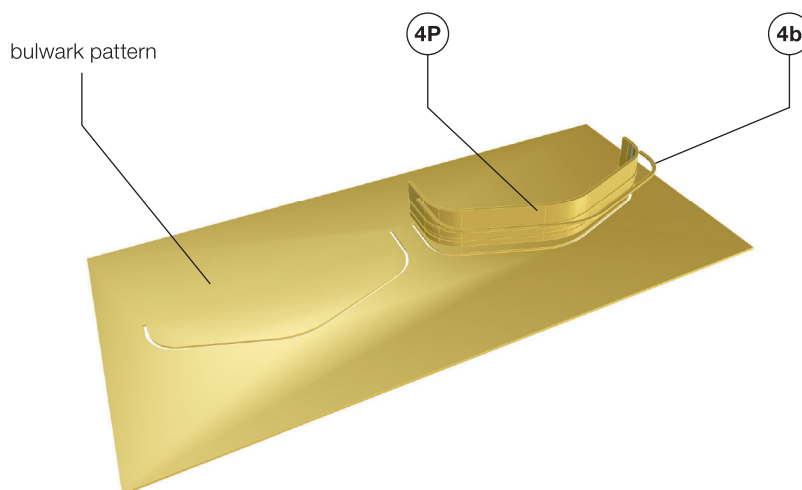

- AL** Anchor lift base – fold part 10 first and then apply part 11 on top of it.

Resin parts R35 and lifts R23 as well as brass flywheels (32) mounted on 0.4 mm and 0.8 mm long rods of 0.3 mm diameter complete the anchor lift assembly.

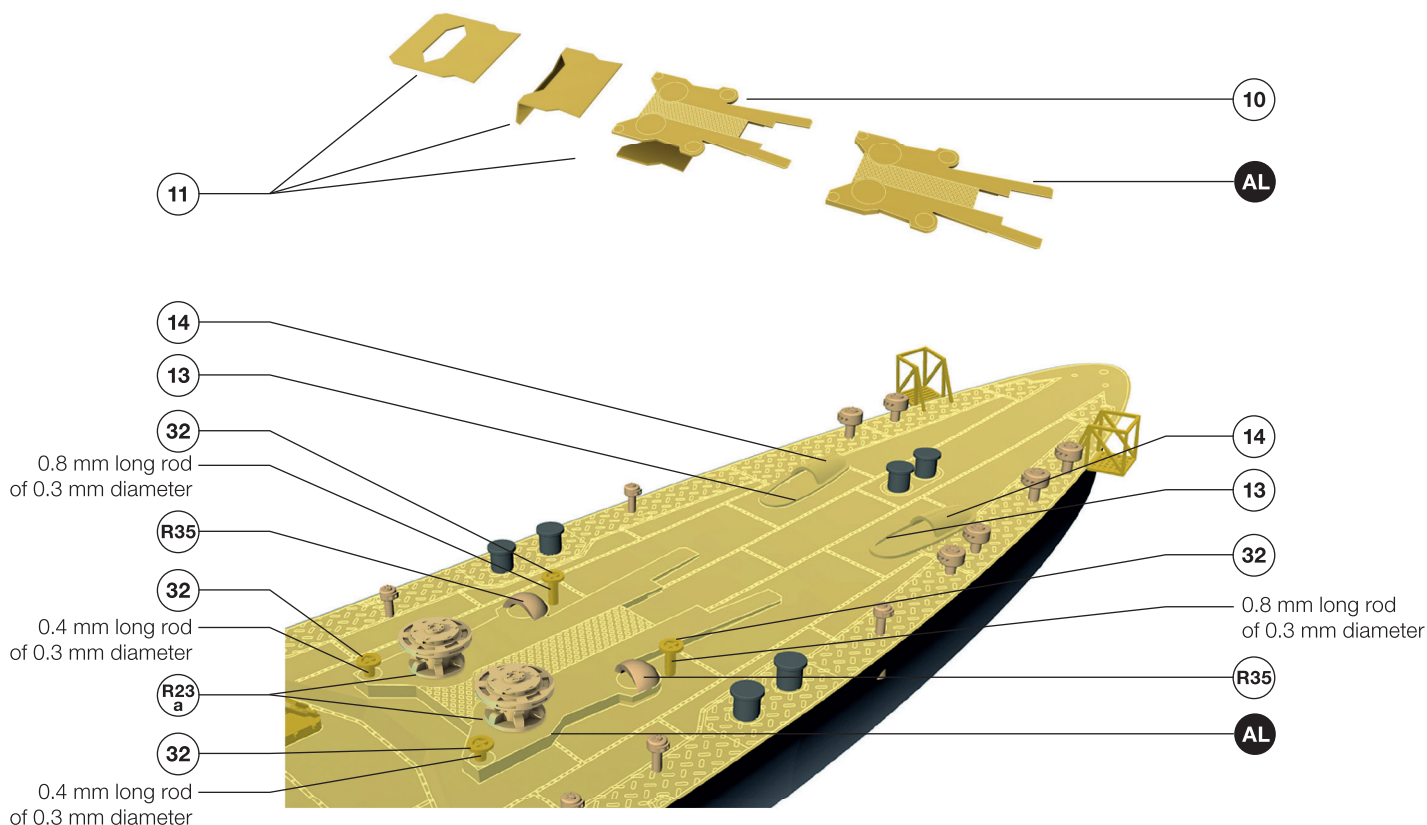

To further enhance your build use our IJN Anchors for Cruisers (SO7000193) and IJN Chains set for Cruisers (SO7000203) sets.